

PRODUCT SPECIFICATION

Model No.: FYLS-0603BUVAC

Features:
<ul style="list-style-type: none"> ■ SMD Type ■ Size (mm):1.60*0.80*0.60 ■ Emitting Color:Ultraviolet ■ SMT package ■ Suitable for all SMT assembly and soldering method ■ Pb-free Reflow soldering application ■ RoHS Compliant ■ MSL:4

Applications:
<ul style="list-style-type: none"> ■ Ultraviolet disinfection. ■ Phototherapy. ■ Bio-Analysis/Detection. ■ Currency Detectors ■ Insect Trap lamps ■ Mine Identification ■ Plant Growth Lamps



CUSTOMER APPROVED SIGNATURES	APPROVED BY	CHECKED BY	PREPARED BY

NINGBO FORYARD OPTOELECTRONICS CO.,LTD.

Add:No. 666 Jinghua Road, Hi-tech Park, Ningbo, Zhejiang, China

Zip:315103

Tel: 0086-574-87933652 87927870

Fax: 0086-574-87927917

E-mail:Sales@foryard.com (General)

Model No.: FYLS-0603BUVAC

■ Mechanical Dimensions

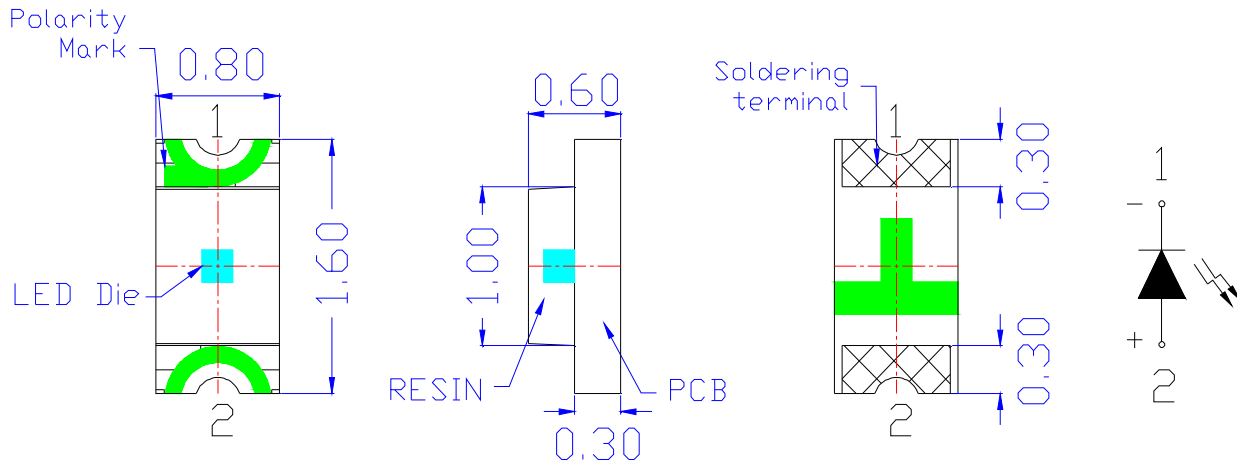

■ Recommend Soldering pad design(unit=mm)

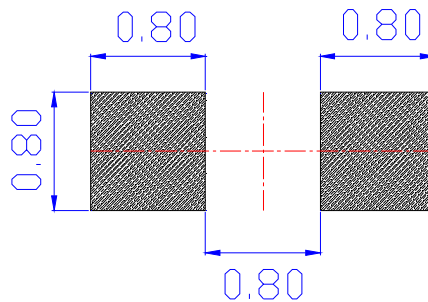

Notes:

1. Dimension in millimeter, tolerance is ± 0.10 .
2. Angle: $\pm 5^\circ$
3. The specifications, characteristics and technical data described in the datasheet are subject to change without prior notice.
4. The drawing is different from the actual one, please refer to the sample.

Model No.: FYLS-0603BUVAC

■ Absolute maximum ratings

Parameter	Symbol	MAX.	Unit
Power Dissipation	PD	100	mW
Peak Forward Current*	IFP	60	mA
Continuous Forward Current	IF	30	mA
Reverse Voltage	VR	5	V
Operating Temperature Range	Topr	-40~ +85	°C
Storage Temperature Range	Tstg	-40~ +85	°C
Soldering Temperature	Tsol	Reflow soldering : 260°C , 10s	
		Hand soldering : 300°C , 3s	

*1/10 Duty Cycle, 0.1ms Pulse Width

■ Typical Electrical & Optical Characteristics(Ta=25°C)

Parameter	Symbol	Test Condition	Min.	Typ.	Max.	Unit
Luminous Intensity	I_V	IF=20mA	8.00	---	24.00	mcd
Viewing Angle	$2\theta_{1/2}$	IF=20mA	---	120	---	Deg
Peak Emission Wavelength	λ_p	IF=20mA	390	---	410	nm
Dominant Wavelength	λ_d	IF=20mA	415	---	430	nm
Forward Voltage	V_F	IF=20mA	2.60	---	3.60	V
Reverse Current	I_R	VR=5V	---	---	10.00	μ A

■ Material

Item	Reflector	Encapsulate	Wire	Chip
Material	PPA	Epoxy	Gold	InGaN

Note:

- 1.Luminous Intensity is based on the Foryard standards.
- 2.Pay attention about static for InGaN

■ The Luminous Intensity Grade of Products(Unit: mcd) ;Test Condition : If=20mA,Ta=25°C

Code	P06	P07	P08	P09	P10	P11
Luminous Intensity(mcd)	8~10	10~12	12~14	14~17	17~20	20~24

Tolerance of measurement of luminous intensity is $\pm 15\%$

■ Dominate Wavelength Grade of Products (Unit: nm); Test Condition: If=20mA,Ta=25°C

Code	2	3	4	5
Dominate Wavelength(nm)	390~395	395~400	400~405	405~410

Tolerance for each Dominate Wavelength bin is ± 1 nm

■ Forward Voltage Grade of Products (Unit: V); Test Condition: If=20mA,Ta=25°C

Code	13	14	15	16	17	18	19	20	21	22
Forward Voltage(V)	2.6-2.7	2.7~2.8	2.8~2.9	2.9~3.0	3.0~3.1	3.1~3.2	3.2~3.3	3.3~3.4	3.4~3.5	3.5~3.6

Tolerance of measurement of forward voltage is ± 0.1 V

Model No.: FYLS-0603BUVAC

Electrical-Optical Characteristics-

Forward Current VS. Forward Voltag (Ta=25°C)

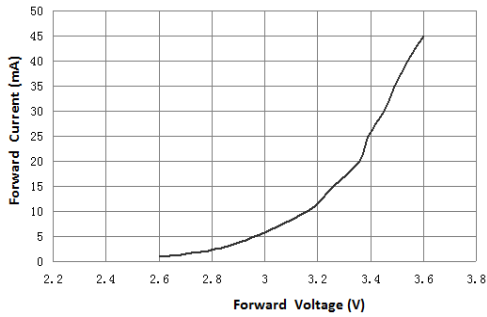

Spectrum Distribution (Ta=25°C)

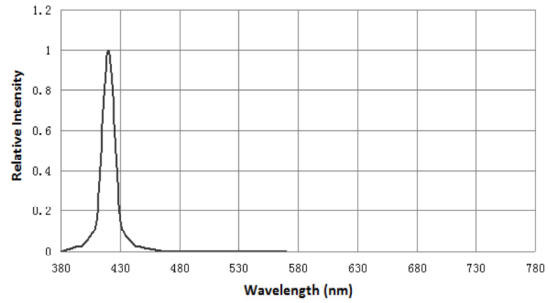

Relative Intensity VS. Ambient Temperature (Ta=25°C)

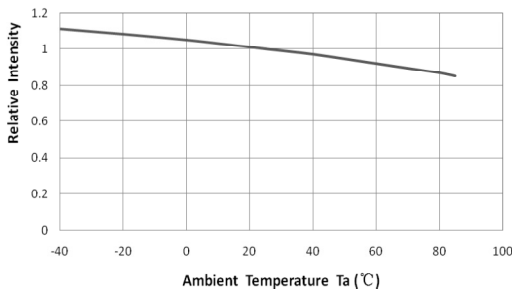

Relative Intensity VS. Forward Current (Ta=25°C)

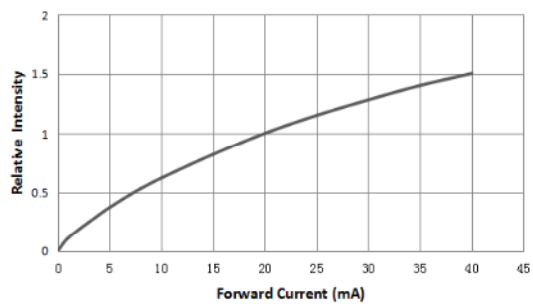

Maximum Forward Current VS. Ambient temperature

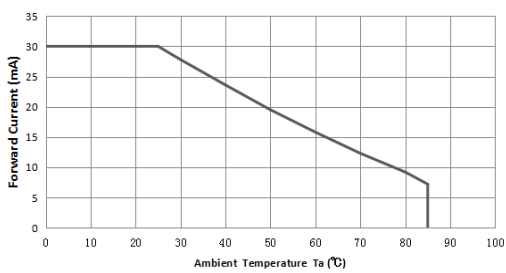
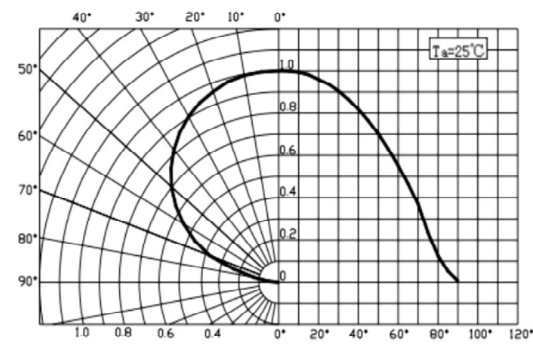

Diagram characteristics of radiation



NOTE:25°C free air temperature unless otherwise specified

Model No.: FYLS-0603BUVAC

■ Package-

1. Reel Dimension

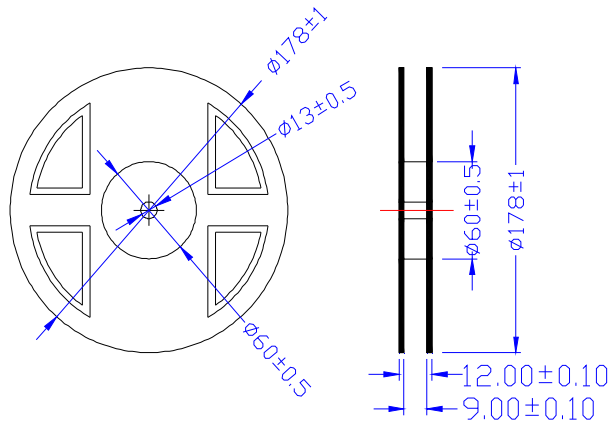

2. Tape Dimension

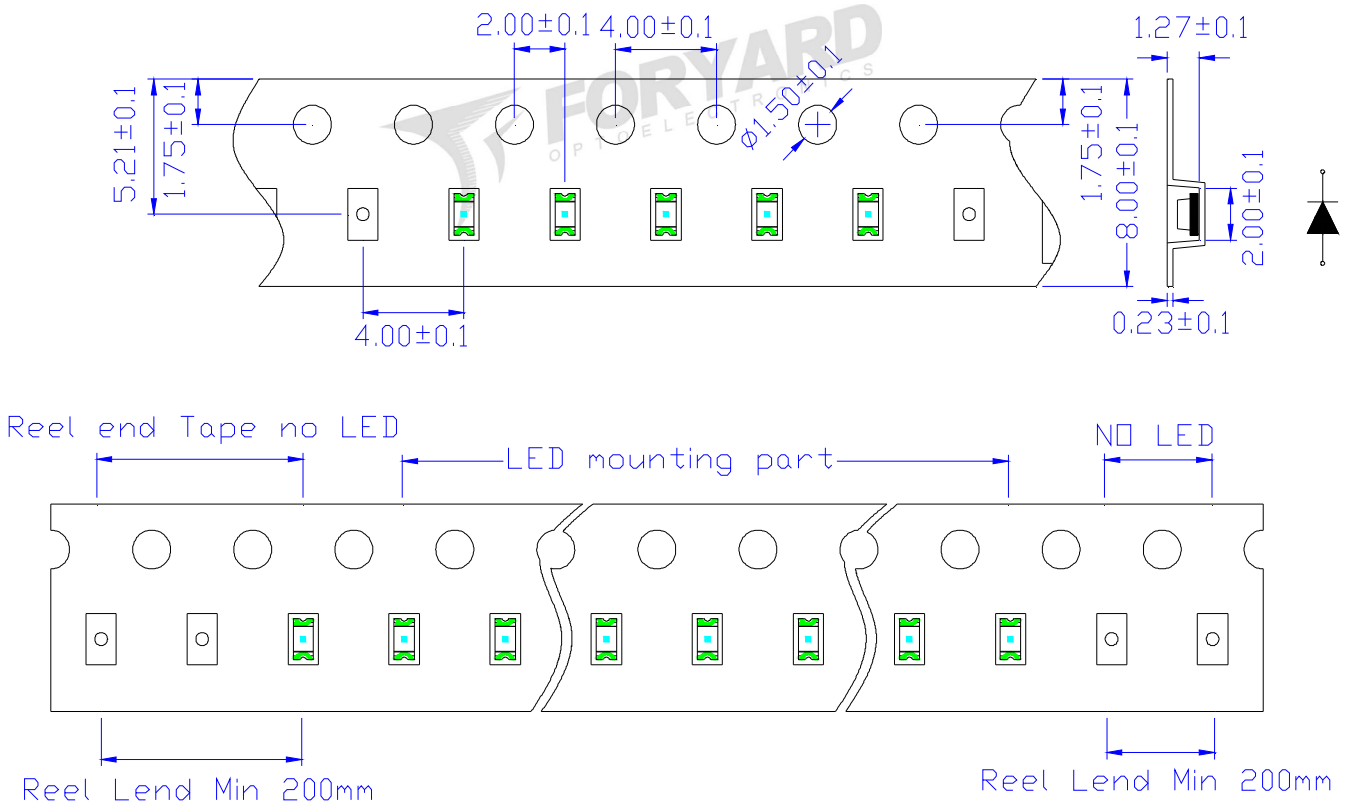



Notice:

1. Tolerance unless mentioned is $\pm 0.2\text{mm}$

Model No.:	FYLS-0603BUVAC
Date / Rev.	2023.03.21 / B

Model No.: FYLS-0603BUVAC

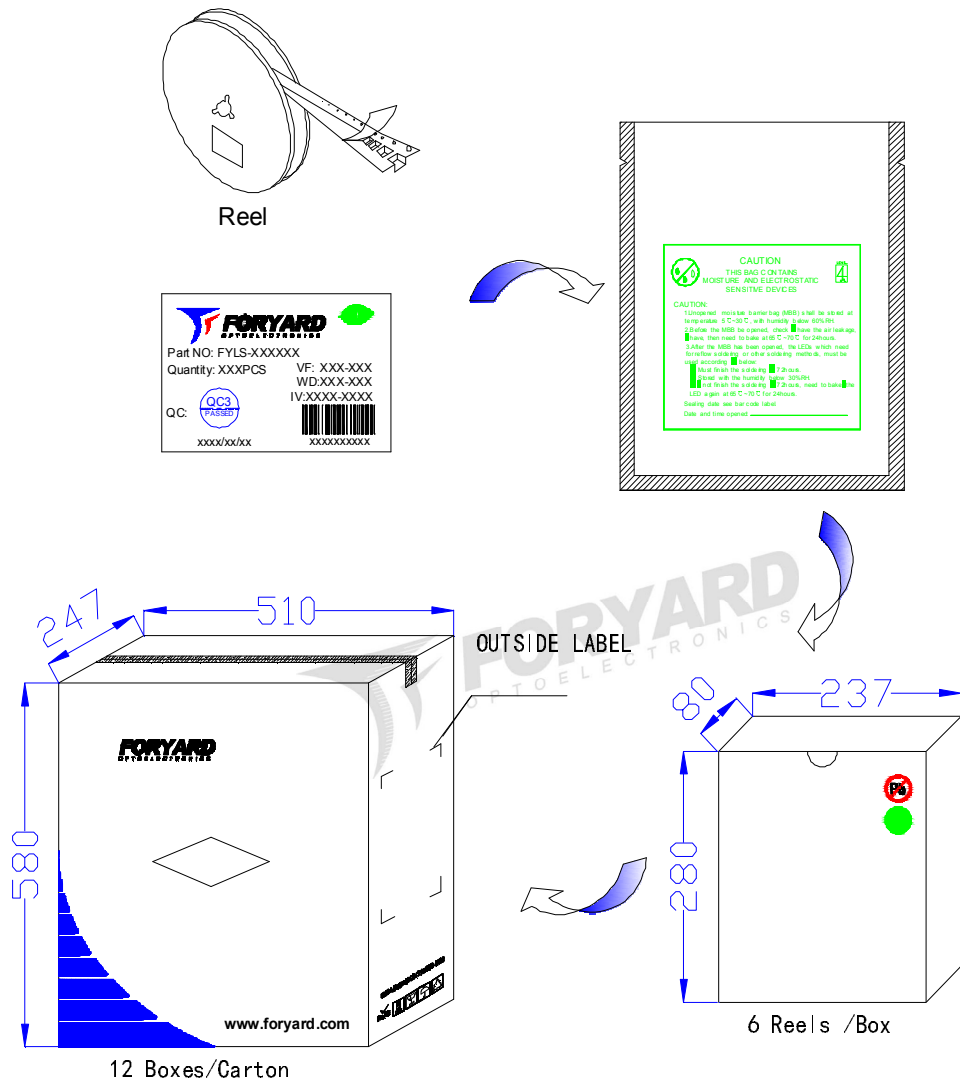

3. Packing Diagram

LED
PN: FYLS-XXXXXXXXXX
Qty: XXXXX PCS
Date: XXXX/XX/XX
GW: XX.XX KG
NW: XX.XX KG



XXXXXXXXXX

OUTSIDE LABEL

Notice:

- 1.Quantity:4000 PCS/Reel
- 2.The specifications are subject to change without notice. Please contact us for updated information.

Model No.: FYLS-0603BUVAC

■ Soldering Characteristics-

● Reflow Soldering

● Lead Solder

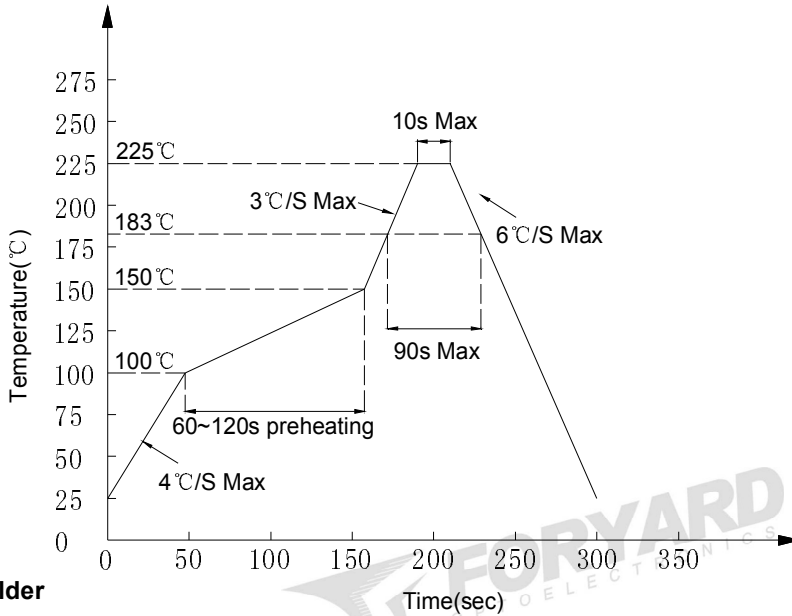

● Lead-free Solder

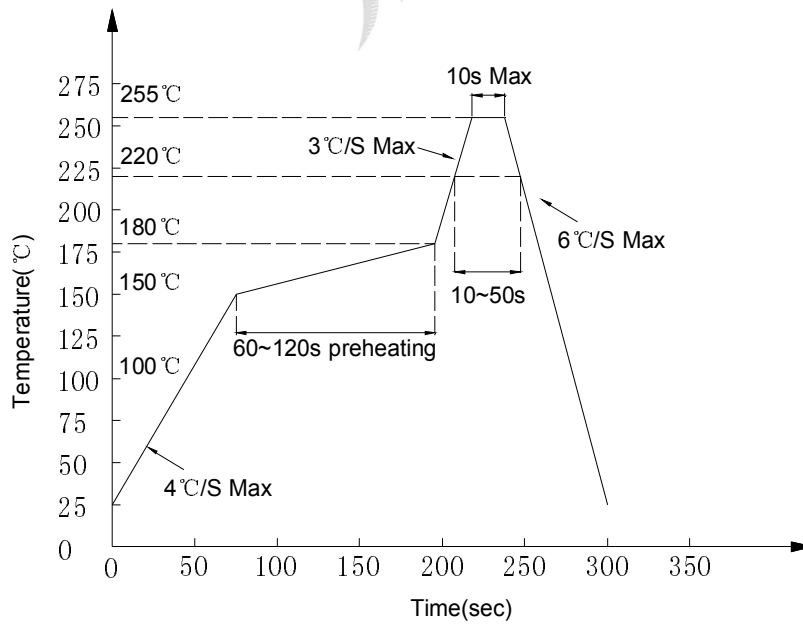

Notes:

1. Although the recommended soldering conditions are specified in above table, reflow or hand soldering at the lowest possible temperature is desired for the LEDs.
2. A rapid-rate process is not recommended for cooling the LEDs down from the peak temperature.
3. All temperatures refer to solder Pad.

● Hand Soldering

Soldering temperature	300°C Max. (25W Max.)	One time only
Soldering time	5 ±1sec	

Model No.: FYLS-0603BUVAC

■ **Handling of Silicone Resin LEDs-**

● **Handling Indications**

When handling the product, do not touch it directly with bare hands as it may contaminate the surface and affect on optical characteristics. In the worst cases, excessive force to the product might result in catastrophic failure due to package damage and/or wire breakage.

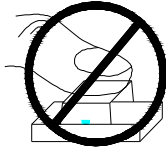

When handling the product with tweezers, LEDs should only be handled from the side and make sure that excessive force is not applied to the resin portion of the product. Failure to comply can cause the resin portion of the product to be cut, chipped, delaminated and/or deformed, and wire to be broken, and thus resulting in catastrophic failure.

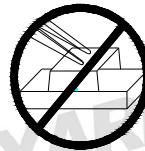
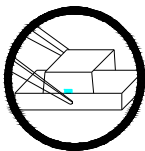

■ **Recommended circuit-**

● In designing a circuit, the current through each LED must not exceed the absolute maximum rating specified for each LED. It is recommended to use Circuit B which regulates the current flowing through each LED. In the meanwhile, when driving LED with a constant voltage in Circuit A, the current through the LEDs may vary due to the variation in forward voltage (VF) of the LEDs. In the worst case, some LED may be subjected to stresses in excess of the absolute maximum rating.

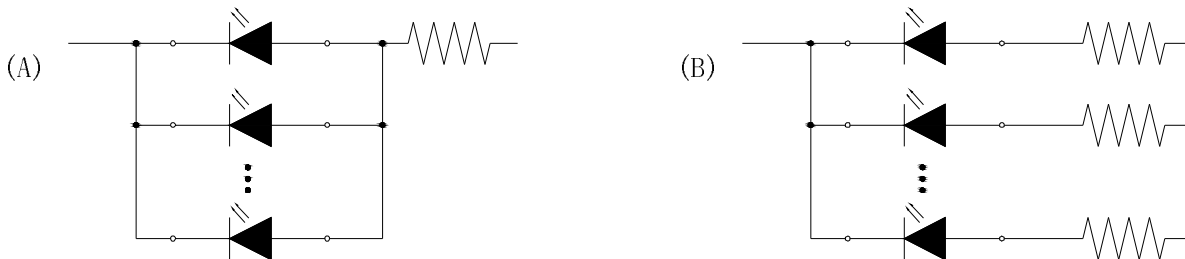

● This product should be operated in forward bias. A driving circuit must be designed so that the product is not subjected to either forward or reverse voltage while it is off. In particular, if a reverse voltage is continuously applied to the product; such operation can cause migration resulting in LED damage.

■ **Storage-**

● **Storage Conditions**

1. Unopened moisture barrier bag (MBB) shall be stored at temperature below 5°C~30°C, with humidity below 60%RH.
2. Before the MBB be opened, check if have the air leakage, if have, then need to bake at 65°C~70°C for 24hours.
3. After the MBB has been opened, the LEDs which need for reflow soldering or other soldering methods, must be used according to below:
 - a: Must finish the soldering in 72hours
 - b: Stored with the humidity below 30%RH
 - c: If not finish the soldering in 72hours, need to bake the LED again at 65°C~70°C for 24hours