

A PERFECT ALLIANCE.

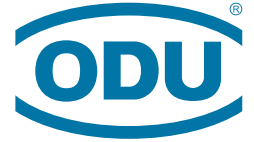

# ODU AMC<sup>®</sup> HIGH-DENSITY

Ruggedized miniature circular connector

BREAK-AWAY  
SCREW-LOCK



ODU AMC<sup>®</sup> HIGH-DENSITY

ODU AMC<sup>®</sup>

ODU AMC<sup>®</sup> EASY-CLEAN

ODU THREADED CONNECTOR

# ODU AMC® HIGH-DENSITY

## FEATURES

- High contact-density connector
- High-speed data transfer capability, including:
  - USB® 3.2 Gen 1x1
  - 10 G Ethernet
  - HDMI®
- Rugged, robust housing with non-reflective surface plating
- Submersible, watertight protection classes IP68 / IP69 / IP6K8 / IP6K9K
- Up to 5,000 mating cycles durability
- Break-Away for maximum safety
- Mechanical coding with color-coded visual indicator
- Contacts for solder cup and PCB termination

## APPLICATIONS

- Tactical radios and accessories
- Ruggedized computers and tablets
- Power supply
- Unmanned systems
- Optical devices
- Software defined radios
- Defence and security systems



All shown connectors and cable assemblies are defined without breaking capacity (COC) according to IEC 61984:2008 (VDE 0627:2009). All shown connectors and cable assemblies are rated to a safety extra low voltage (SELV) of less than 50 V AC / 75 V DC, according to IEC 61140:2016 (VDE 0140-1:2016). For more details, please refer to page [56](#).

ODU AMC® High-Density is UL-listed under file E110586.

Issue: 2021-03

### Data transmission protocols

These ODU specific connectors can transmit common data transmission protocols such as HDMI®, USB® 2.0 and USB® 3.2 Gen1x1, but they are not HDMI®- and USB®-standard connectors.

Printed on certified recycled paper.



# TABLE OF CONTENTS

Clickable page  
numbers

THE ODU CORPORATE GROUP .....	<u>4</u>
PRODUCT INFORMATION .....	<u>11</u>
ODU AMC® High-Density introduction – a highly reliable connector solution .....	<u>12</u>
ODU AMC® High-Density .....	<u>12</u>
ODU AMC® High-Density connectors – locking style options .....	<u>13</u>
Related products in the ODU circular connector series .....	<u>13</u>
ODU AMC® High-Density locking mechanisms .....	<u>14</u>
Connector variations .....	<u>15</u>
CONFIGURATION GUIDELINE .....	<u>17</u>
ODU AMC® HIGH-DENSITY SERIES .....	<u>23</u>
Summary ODU AMC® High-Density .....	<u>24</u>
Break-Away plug .....	<u>26</u>
In-line receptacle .....	<u>27</u>
Panel mount receptacle .....	<u>28</u>
Break-Away plug with Screw-Lock .....	<u>30</u>
In-line receptacle for Screw-Lock .....	<u>31</u>
Panel mount receptacle for Screw-Lock .....	<u>33</u>
Factory-terminated flex assemblies .....	<u>34</u>
Coding options .....	<u>35</u>
Housing material .....	<u>35</u>
Contact configurations and PCB details .....	<u>36</u>
Protective caps .....	<u>44</u>
Custom parts .....	<u>45</u>
Assembly and crimp tools .....	<u>46</u>
TECHNICAL INFORMATION .....	<u>49</u>
Technical data ODU AMC® High-Density .....	<u>50</u>
Material and surface treatment .....	<u>51</u>
International protection classes .....	<u>52</u>
Protection of ODU AMC® High-Density .....	<u>53</u>
Conversions / AWG .....	<u>54</u>
Current load of turned contacts .....	<u>55</u>
Explanations and information to voltage ratings and safety requirements .....	<u>56</u>
Technical Terms .....	<u>57</u>

# A PERFECT ALLIANCE

## ODU group overview

- Almost 80 years of experience in connector technology
- 2,300 employees worldwide
- Sales subsidiaries in China, Denmark, France, Germany, Hong Kong, Italy, Japan, Korea, Romania, Sweden, UK and the US as well as 5 production and logistics sites
- All technologies under one roof: Design and development, machine tooling and special machine construction, injection, stamping, turning, surface technology, assembly and cable assembly

As of February 2021

## Worldwide customer proximity

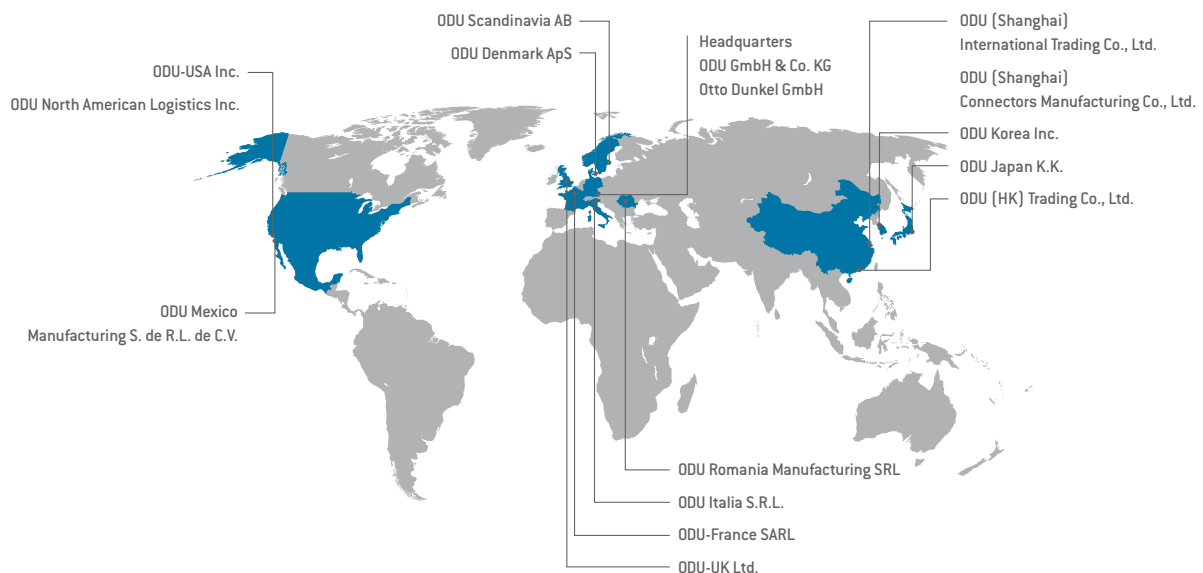



## Certificates & approvals

- ISO 9001
- IATF 16949
- ISO 13485
- ISO 14001
- ISO 50001
- Wide range of UL, CSA, VG and VDE approvals
- UL Wiring Harnesses certified

For a complete list of our certifications and approvals, please visit our website.

## ODU serves the markets



# PRODUCT PORTFOLIO

## Circular Connectors

- Circular connector series in robust metal or plastic housing
- Different locking systems available: Push-Pull and Screw-Lock options or Break-Away for quick release
- Contacts for soldering, crimping and PCB termination
- 2 up to 55 contacts and protection classes IP50 to IP69
- Autoclavable for medical applications
- Hybrid inserts for combined transmission



## Cable Assembly

- One point of contact for the complete solution
- State-of-the-art manufacturing facilities for small, medium and high volumes at production sites worldwide
- Overmolding in silicone, hot-melt and high-pressure procedures
- Customer-specific labeling and cable printing
- Wide range of standard cables and accessories available
- Rapid prototyping and fast customer samples



## Electrical Contacts

- Versatile contact technologies with high reliability and durability
- Current-carrying capacity of up to 2,400 A
- Rugged and universal contact systems
- Stamping technology for customer-specific high volume solutions
- Very high vibration and low, stable contact resistance





## Modular Connectors

- Application-specific hybrid interface
- Manual mating and automatic docking
- Flexible modular design and highest packing density
- High variety of locking options
- Mating cycles scalable as required from 10,000 to over 100,000 (1 million)
- Transmission of signals, power, high current, high voltage, HF signals (coax), media, high-speed data or fiber optics



## Mass Interconnect Solutions

- For testing printed circuit boards (PCBs) and electronically assembled units
- Innovative engagement option: electromechanical version with remote control available
- 8 tensioning points stop the frame distortion
- Maximum flexibility with ODU-MAC® modules and signal blocks
- Adapter frame (ITA) with tolerance compensation
- Easy maintenance access for a simple and fast modification

# FINDING BEST SOLUTIONS

SUPPORT FROM START TO FINISH –  
WE ARE HAPPY TO ADVISE YOU

[sales@odu.de](mailto:sales@odu.de)







## ODU EXPRESS

Products selected online from the ODU Product Finder, which display the ODU Express Logo, can be shipped in quantities of up to 150 pcs in 15 working days or less, anywhere in the world.

We therefore recommend to use ODU Express for time-sensitive projects in particular. Our customer consultants are happy to advise you on current delivery times.

### ODU Product Finder

The ODU Product Finder selects your required connector solution from thousands of ODU products and supplies you with the right data sheet and STP file.

### ODU Product sample box

See, feel and test our products before you order. Choose your configuration in the ODU Product Finder.



[odu-productfinder.com](https://www.odu-productfinder.com)





# ODU AMC<sup>®</sup> HIGH-DENSITY



## PRODUCT INFORMATION

ODU AMC® High-Density introduction .....	<a href="#">12</a>
ODU AMC® High-Density .....	<a href="#">12</a>
ODU AMC® High-Density – locking style options .....	<a href="#">13</a>
Related products in the ODU Circular connector series .....	<a href="#">13</a>
ODU AMC® High-Density locking mechanisms .....	<a href="#">14</a>
Connector variations .....	<a href="#">15</a>

# ODU AMC<sup>®</sup> HIGH-DENSITY INTRODUCTION – A HIGHLY RELIABLE CONNECTOR SOLUTION

ODU AMC<sup>®</sup> High-Density is a rugged, ultra-miniature connector solution for extreme environments. Available in connector diameters as small as 7 mm, the ODU AMC<sup>®</sup> High-Density connector line proves that premium quality can also come in small packages.

In addition to discrete signal options, the product line includes versions for "Power" (up to 15 A) and "Data Transfer" (USB<sup>®</sup> 3.2 Gen 1×1, 5 A power) in compact, high-density configurations.

The ODU AMC<sup>®</sup> High-Density connector offers an impressively long service life of more than 5,000 mating cycles, even under challenging conditions. Intuitive mate and demate operation, and mechanical color coding aid operators and reduce user error.

The connector is available in two locking styles standard. Break-Away connectors can be easily disconnected by tugging on the cable, and are ideal whenever the cable is a potential snag hazard. Screw-Lock connectors remain connected despite environmental conditions, including tension on the cable, shock and vibration.



## ODU AMC<sup>®</sup> HIGH-DENSITY

### VARIOUS SIZES AND CONFIGURATIONS AVAILABLE

- Metal connector plug housing deliverable in 3 sizes
- Outer diameter 7 mm to 15 mm
- Number of contacts 2 to 27
- Inserts for high-speed data transmission
- International protection class IP68 / IP69
- Salt spray resistance
- Tested according to various MIL standards
- Mechanical and color coding
- Uniform distance from mounting flange to PCB, allows multiple connectors to be placed on the same board

### MATERIALS AND APPLICABILITY



The ODU AMC<sup>®</sup> High-Density connector series uses PEEK as the insulator material. The housings are made of brass, and plated with ruthenium over nickel (See page [35](#) for more information). Operating temperature range: -57 °C to +125 °C. This rugged and versatile connector series is ideal for defense & security applications as well as industrial electronics.

### COMPLETE SYSTEM SOLUTION

Every connection has a unique cable requirement. Make no compromise when it comes to the quality of the complete interconnect system. ODU gives you the complete system solution from one source, without the need for an intermediary supplier. Services include:

- 100% outgoing inspection
- ISO 14644-1:2015 clean room assembly available
- Factory-automated equipment and processes (cutting, stripping, etc.)
- Low- and high-pressure overmolding
- Ultrasonic welding
- EMI shielded enclosure assembly
- Custom labeling
- Various potting options for sealed systems
- Overmolded cable transitions (1-to-2, 1-to-3, etc.)

# ODU AMC® HIGH-DENSITY CONNECTORS – LOCKING STYLE OPTIONS

	Coding	Size	No. of possible mechanical and optical codings	Plug diameter in mm	Max. cable diameter in mm	Number of max. contacts	High-Speed inserts	Solder	PCB	International protection class A <sup>1</sup>
<b>BREAK-AWAY</b> 	Pin and groove	00	4	9.8	5	7	•	•	•	up to IP6K9K
		0		12.8	7	16				
		1		14.8	8.5	27				
<b>BREAK-AWAY WITH SCREW-LOCK</b> 	Pin and groove	00	4	9.8	5	7	•	•	•	up to IP6K9K
		0		12.8	6.5	16				
		1		14.8	8	27				

<sup>1</sup> International protection class in mated condition

## RELATED PRODUCTS IN THE ODU CIRCULAR CONNECTOR SERIES



- Signal, Power and high-speed data technology
- Secure Push-Pull locking and Break-Away function
- Contacts for solder and PCB termination
- International protection class IP6K9K



- Pogo pin contacts can be easily cleaned and are resilient against damage caused by dirt and debris ingress
- Break-Away function
- International protection class IP6K8 and IP6K9K

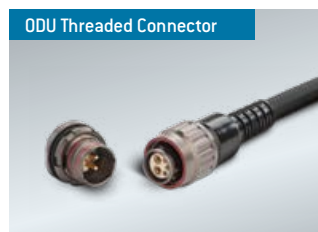

- High reliability for harsh environments
- Screw locking with “ratchet mechanism” half turn locking
- High vibration resistant
- International protection class IP6K8
- More mate cycles than MIL spec. connectors



- Circular Push-Pull connector with metal housing
- Wide variety of contact configurations and combinations
- International protection class IP50 and IP68

# ODU AMC® HIGH-DENSITY LOCKING MECHANISMS

ODU offers you high-quality connectors and comprehensive service for the complete assembly. From connectors to submersible overmolded cable assemblies, we provide the complete system as an one-stop solution.

## BREAK-AWAY FUNCTION

The Break-Away function allows connectors to be mated and unmated quickly and reliably. During the mating process, a locking ring inside the receptacle engages corresponding grooves on the plug. Once established, the connection will be maintained as long as axial tension on the plug is less than the release limit of the connector system.

The retention mechanism is strong enough to resist minor tension. Pulling lightly on the plug or cable assembly will have no impact on the connection.

If the plug or cable assembly is pulled forcefully, and the release limit of the connector is exceeded the connectors will separate.

Features in the connector allow the plug and receptacle to separate when the either the plug or the plug cable assembly is pulled axially away from the receptacle with enough force to overcome the retention mechanism.

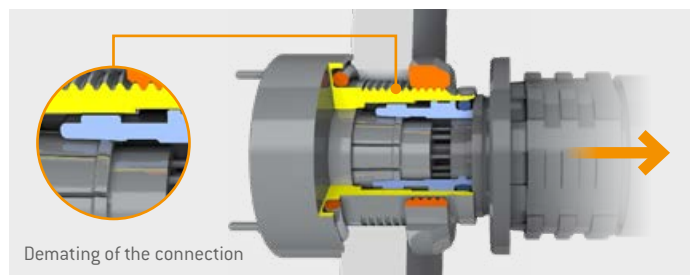
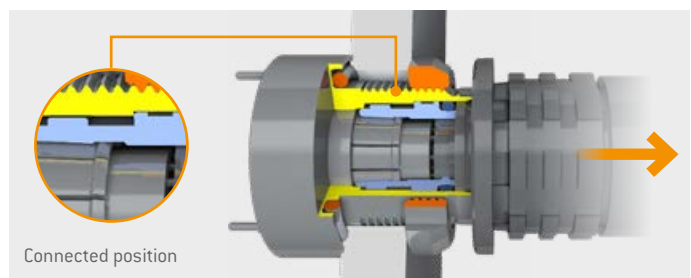

## SCREW-LOCK FUNCTION

Just like in the Break-Away connectors described above, during the mating process a locking ring inside the receptacle engages corresponding grooves on the plug. Once the connector is fully engaged, an operator can engage the secondary Screw-Lock mechanism by rotating the outer coupling sleeve. Once engaged, the connector will stay mated until the Screw-Lock mechanism is disengaged. Pulling on the plug connector or plug cable assembly will not cause the connector to separate.

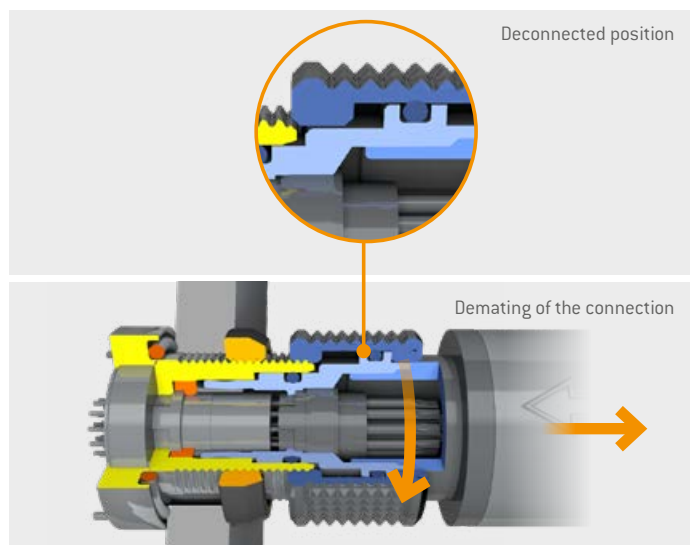

# CONNECTOR VARIATIONS

RECEPTACLE IN-LINE RECEPTACLE	PLUG	SCREW-LOCK FUNCTION	BREAK-AWAY FUNCTION
<p>Style GK [Page <a href="#">28</a>]</p> 	 <p>Style A1 [Page <a href="#">26</a>]</p>		
<p>Style G6 [Page <a href="#">29</a>]</p> 			
<p>Style K1 [Page <a href="#">27</a>]</p> 			
<p>Style GK [Page <a href="#">28</a>]</p> 	 <p>Style C1 [Page <a href="#">30</a>]</p>		
<p>Style G5 [Page <a href="#">33</a>]</p> 			
<p>Style K1 [Page <a href="#">27</a>]</p> 			
<p>Style GC [Page <a href="#">33</a>]</p> 	 <p>Style A1 [Page <a href="#">26</a>]</p>		
<p>Style G5 [Page <a href="#">32</a>]</p> 			
<p>Style KC [Page <a href="#">31</a>]</p> 			
<p>Style GC [Page <a href="#">32</a>]</p> 	 <p>Style C1 [Page <a href="#">30</a>]</p>		
<p>Style G5 [Page <a href="#">33</a>]</p> 			
<p>Style KC [Page <a href="#">31</a>]</p> 			



# ODU AMC<sup>®</sup> HIGH-DENSITY





# CONFIGURATION GUIDELINE

Correct configuring – step by step

# STEP-BY-STEP TO THE PERFECT CONNECTION

ODU offers you high-quality connectors and comprehensive service for the complete assembly. From connectors to watertight potting, we provide the complete system from a single source.



# SAMPLE CONFIGURATION STEP BY STEP

The perfect product for you in just a few steps. These step-by-step instructions shows you how to configure your own individual product with the ODU part number key based on a sample configuration.



Plug in style 1 / size 0 / series W / coding A / connector housing ruthenium over aluminium / insulator PEEK / 16 contacts / solder pin / contact diameter 0.3 / termination cross section AWG 28 /

## STEP 1: SERIES (SEE POSITION 4)

1	2	3	4	5	6	7	8	9	10	11	12	13	14	15	16	17	18	19
			W		M	-	P						0	-	0	0	0	

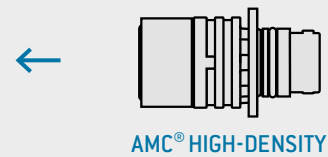

## STEP 2: STYLE (SEE POSITIONS 1 AND 2 )

1	2	3	4	5	6	7	8	9	10	11	12	13	14	15	16	17	18	19
A	1		W		M	-	P						0	-	0	0	0	0



## STEP 3: SIZE (SEE POSITION 3)

1	2	3	4	5	6	7	8	9	10	11	12	13	14	15	16	17	18	19
A	1	0	W		M	-	P						0	-	0	0	0	0

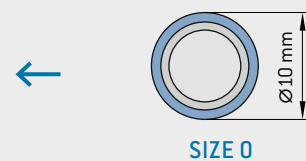

## STEP 4: KEYING (SEE POSITION 5)

1	2	3	4	5	6	7	8	9	10	11	12	13	14	15	16	17	18	19
A	1	0	W	A	M	-	P						0	-	0	0	0	0

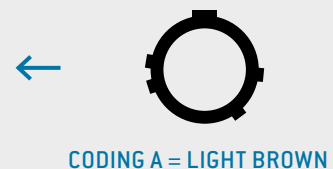

## STEP 5: HOUSING MATERIAL (SEE POSITION 6)

1	2	3	4	5	6	7	8	9	10	11	12	13	14	15	16	17	18	19
A	1	0	W	A	M	-	P						0	-	0	0	0	0



# YOUR WAY TO AN INDIVIDUAL CONNECTION

## HOW TO CONFIGURE WITH THE PART NUMBER KEY

This shows you how ODU's part number key is composed. In the first part of the configuration, select the connector plug housing (such as style and size) of the connector. In the middle part of the part number key, you configure the contact insert and then the cable entry.

### Type

G = Receptacle

K = In-line receptacle

C = Break-Away plug with Screw-Lock

A = Break-Away plug

### Material insulator<sup>1</sup>

(PEEK = Standard)

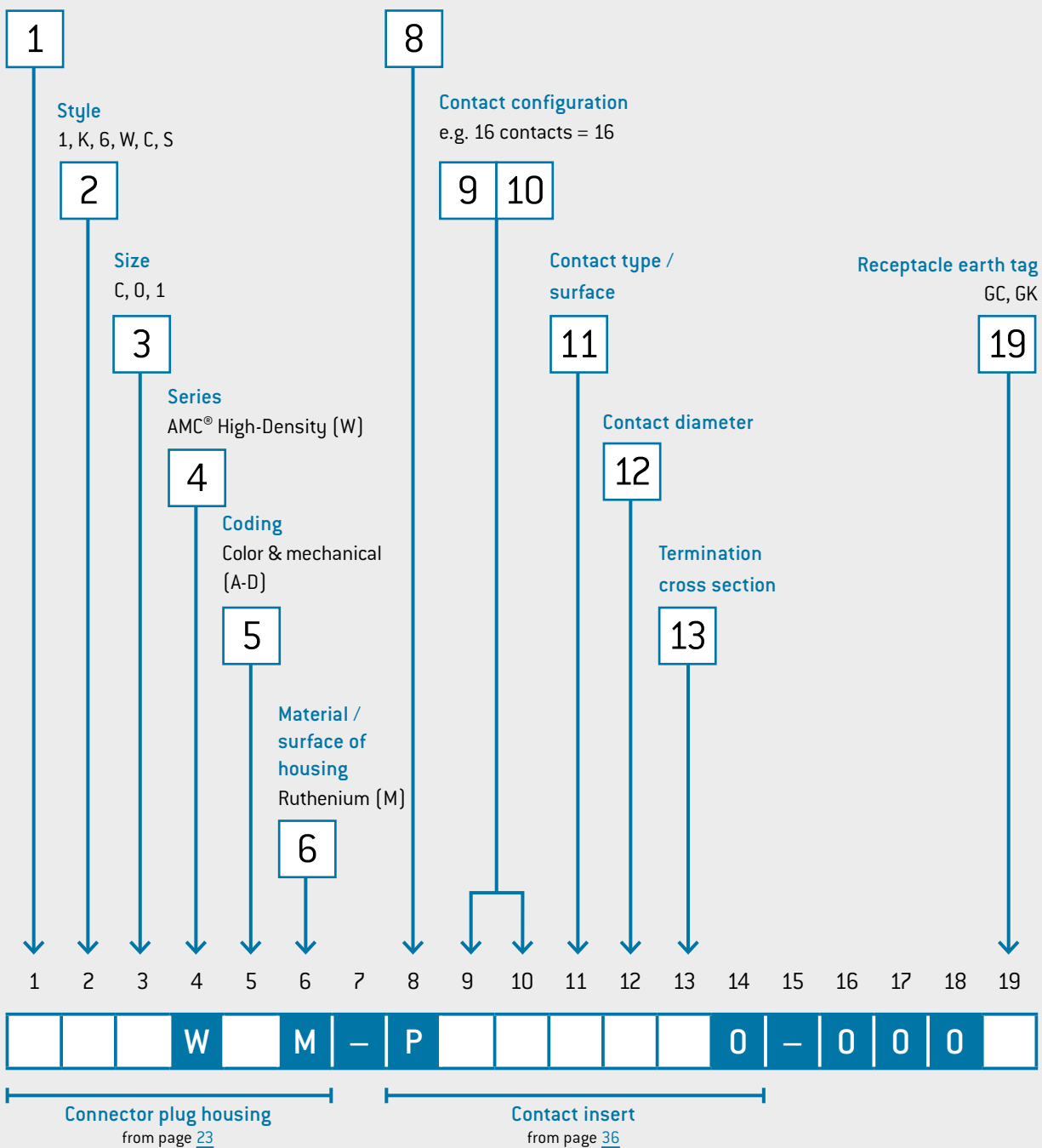

<sup>1</sup>Other insulation materials on request.

STEP 6: INSULATOR MATERIAL (SEE POSITION 8)

1	2	3	4	5	6	7	8	9	10	11	12	13	14	15	16	17	18	19
A	1	0	W	A	M	-	P						0	-	0	0	0	0



PEEK

STEP 7: CONTACT INSERT (SEE POSITIONS 9 AND 10)

1	2	3	4	5	6	7	8	9	10	11	12	13	14	15	16	17	18	19
A	1	0	W	A	M	-	P	1	6				0	-	0	0	0	0

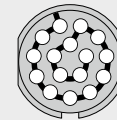

16 CONTACTS

STEP 8: CONTACT TYPE (SEE POSITION 11)

1	2	3	4	5	6	7	8	9	10	11	12	13	14	15	16	17	18	19
A	1	0	W	A	M	-	P	1	6	X			0	-	0	0	0	0



SOLDER (PIN)

STEP 9: CONTACT DIAMETER (SEE POSITION 12)

1	2	3	4	5	6	7	8	9	10	11	12	13	14	15	16	17	18	19
A	1	0	W	A	M	-	P	1	6	X	B		0	-	0	0	0	0

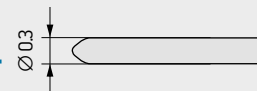

CONTACT DIAMETER 0.3 mm

STEP 10: TERMINATION CROSS-SECTION (SEE POSITIONS 13)

1	2	3	4	5	6	7	8	9	10	11	12	13	14	15	16	17	18	19
A	1	0	W	A	M	-	P	1	6	X	B	C	0	-	0	0	0	0



AWG 28



# ODU AMC<sup>®</sup> HIGH-DENSITY



## ODU AMC<sup>®</sup> HIGH-DENSITY SERIES

Summary ODU AMC <sup>®</sup> High-Density .....	<a href="#">24</a>
Break-Away plug .....	<a href="#">26</a>
In-line receptacle .....	<a href="#">27</a>
Panel mount receptacle .....	<a href="#">28</a>
Break-Away plug with Screw-Lock .....	<a href="#">30</a>
In-line receptacle for Screw-Lock .....	<a href="#">31</a>
Panel mount receptacle for Screw-Lock .....	<a href="#">32</a>
Factory-terminated flex assemblies .....	<a href="#">34</a>
Coding options .....	<a href="#">35</a>
Contact configurations and PCB details .....	<a href="#">36</a>
Protective caps .....	<a href="#">44</a>
Custom parts .....	<a href="#">45</a>
Assembly and crimp tools .....	<a href="#">46</a>

# SUMMARY ODU AMC® HIGH-DENSITY

The ODU AMC® High-Density is coded by pin and groove. These highly robust miniature connector series can be configured in many different ways: a variety of sizes, termination types and contact inserts are available.

- Coding over pin and groove
- 2 – 27 contacts / mixed inserts
- Up to 3 sizes and 2 termination types
- International protection class up to IP68 / IP69
- Up to 5,000 mating cycles
- Contacts for solder and PCB termination

## BREAK-AWAY PLUG

P. [26](#)



A 1

## IN-LINE RECEPTACLE

P. [27](#)



K 1

## PANEL MOUNT RECEPTACLES

P. [28](#)



G K



G 6

For assembly instructions please refer to our website: [www.odu-connectors.com/downloads](http://www.odu-connectors.com/downloads).



**BREAK-AWAY PLUG WITH SCREW-LOCK** P. [30](#)



**IN-LINE RECEPTACLE WITH SCREW-LOCK** P. [31](#)



**PANEL MOUNT RECEPTACLES WITH SCREW-LOCK** P. [32](#)

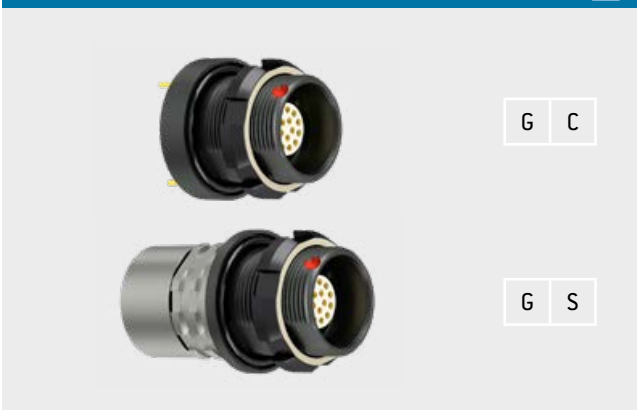

# BREAK-AWAY PLUG

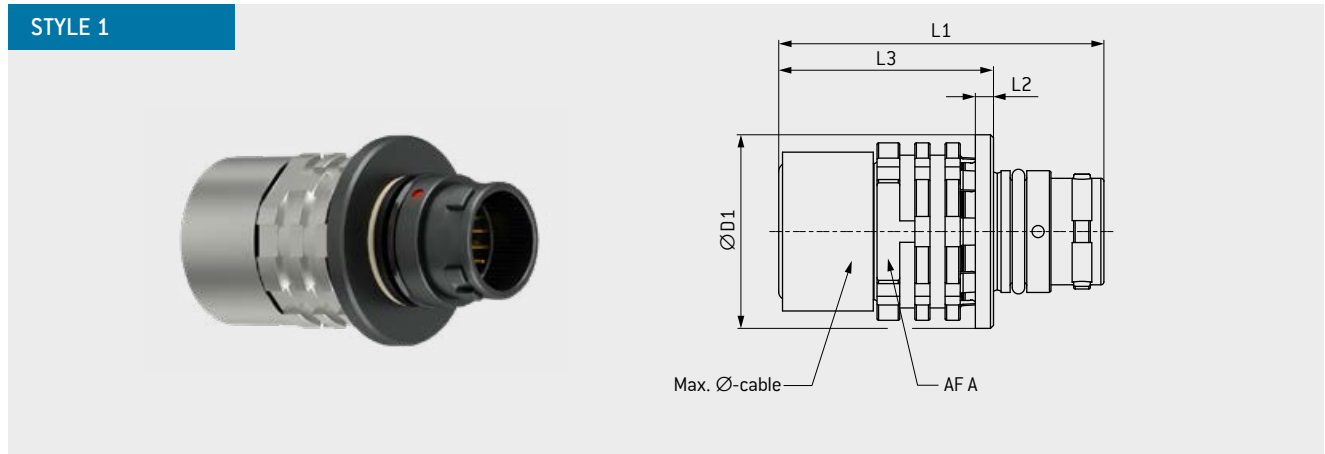

Size		L1 mm	L2 mm	L3 mm	D1 mm	AFA mm	Max. Ø-cable mm
00	<b>C</b>	20	1.2	12.8	9.8	8	5
0	<b>0</b>	21.5	1.2	14.2	12.8	10	7
1	<b>1</b>	25.2	1.2	18.2	14.8	12	8.5

**TECHNICAL DATA**

- IP68 in relation to end device
- Contact configuration see page 36
- Cable assembly information see ODU instruction: 010.650.001.000.001 (available at [www.odu-connectors.com/downloads/assembly-instructions/](http://www.odu-connectors.com/downloads/assembly-instructions/)).

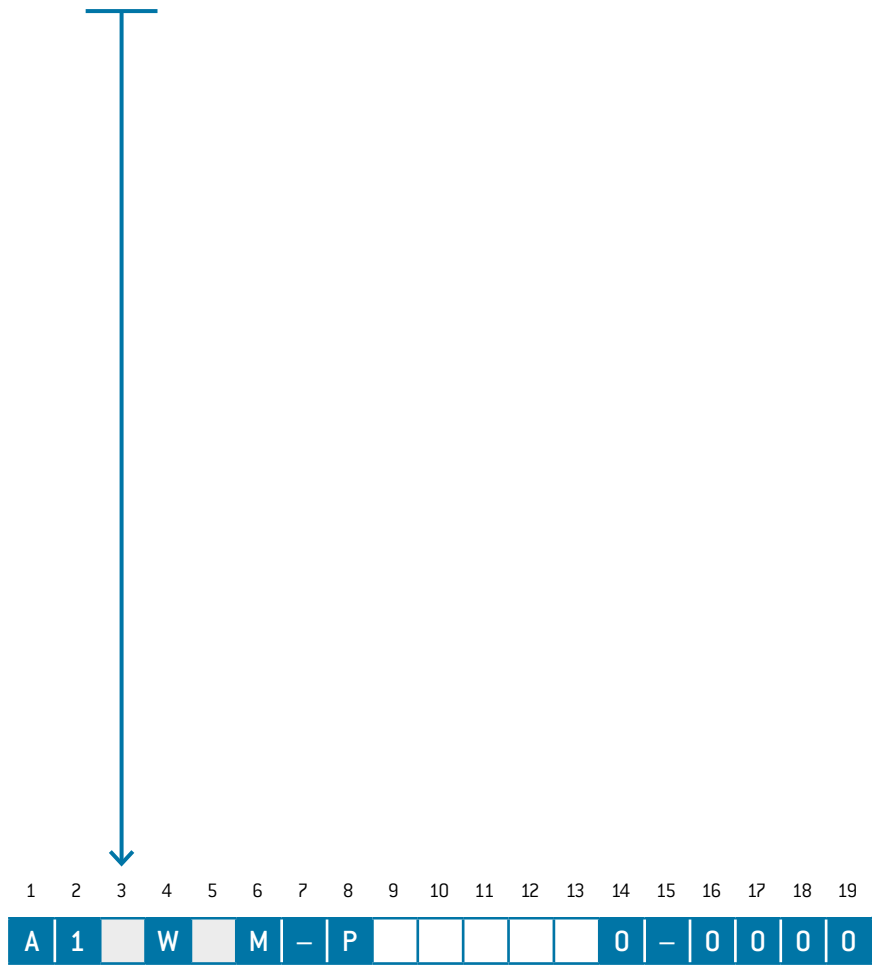

# IN-LINE RECEPTACLE

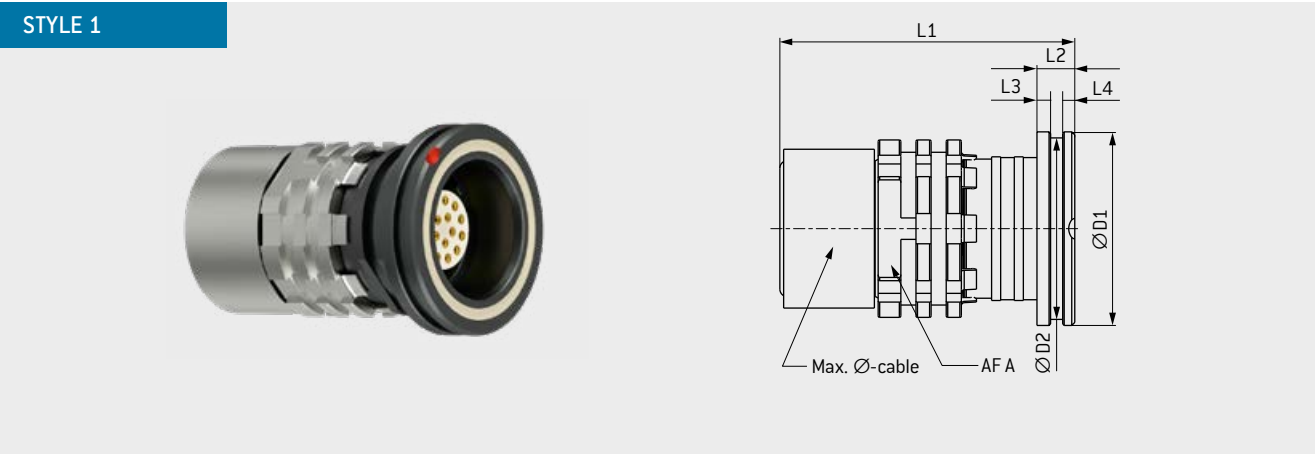

Size		L1 mm	L2 mm	L3 mm	L4 mm	D1 mm	D2 mm	AFA mm	Max. Ø-cable mm
00	<b>C</b>	18.7	2.5	0.8	0.8	9.8	9	8	5
0	<b>0</b>	19.5	2.5	0.8	0.8	12.8	12	10	7
1	<b>1</b>	23.5	2.5	0.8	0.8	14.8	14	12	8.5

**TECHNICAL DATA**

- IP68 in relation to end device
- Contact configuration see page 36
- Cable assembly information see ODU instruction: 010.650.001.000.002 (available at [www.odu-connectors.com/downloads/assembly-instructions/](http://www.odu-connectors.com/downloads/assembly-instructions/)).



1 2 3 4 5 6 7 8 9 10 11 12 13 14 15 16 17 18 19  
**K | 1 | W | M | - | P | | | | | 0 | - | 0 | 0 | 0 | 0**

# PANEL MOUNT RECEPTACLE

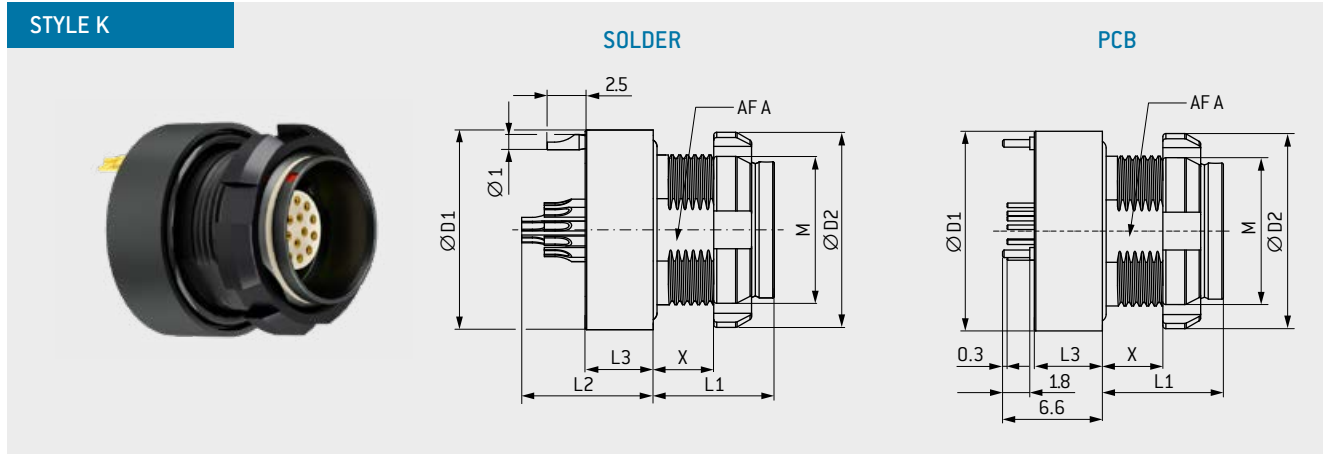

Size		L1 mm	L2 max. mm	L3 mm	X max. mm	D1 mm	D2 mm	AFA mm	M mm	Panel cut out	
										AF	Ø
00	<b>C</b>	8	8.7	4.5	4	10	10	6.5	7 × 0.5	6.6	7.1
0	<b>0</b>	8	8.7	4.5	4	13.2	13	9	10 × 0.5	9.1	10.1
1	<b>1</b>	8	10.2	4.5	4	15.3	15	11.5	12 × 0.5	11.6	12.1

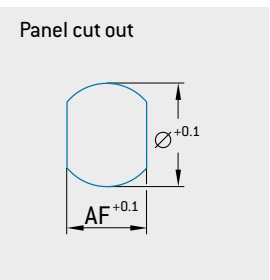

**TECHNICAL DATA**

- IP68 in relation to end device, also in unmated condition
- Contact configuration see page [36](#)
- PCB-Layouts see page [37](#)

↓

1 2 3 4 5 6 7 8 9 10 11 12 13 14 15 16 17 18 19

**G K W M - P 0 - 0 0 0 L**

# PANEL MOUNT RECEPTACLE

## STYLE 6

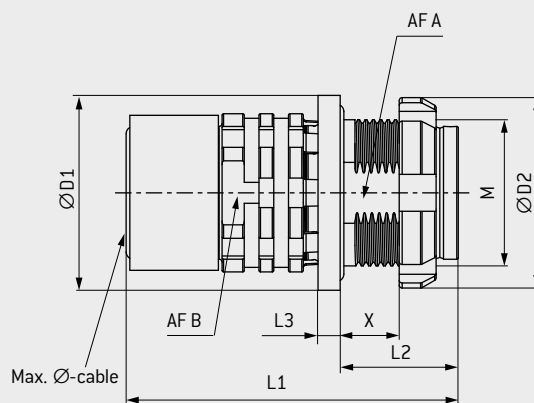

Size		L1 mm	L2 mm	L3 mm	X max. mm	D1 mm	D2 mm	AF A mm	AF B mm	M mm	Panel cut out		Max. Ø-cable
											AF	Ø	
00	<b>C</b>	21	8	1.5	4	9.9	10	6.5	8	7 × 0.5	6.6	7.1	5
0	<b>0</b>	22.5	8	1.5	4	13.2	13	9	10	10 × 0.5	9.1	10.1	7
1	<b>1</b>	26.5	8	1.5	4	15.3	15	11.5	12	12 × 0.5	11.6	12.1	8.5

### Panel cut out

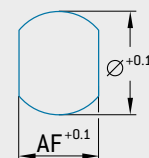

### TECHNICAL DATA

- IP68 in relation to end device, also in unmated condition
- Contact configuration see page [36](#)
- Cable assembly information see ODU instruction: 010.650.001.000.006 [available at [www.odu-connectors.com/downloads/assembly-instructions/](http://www.odu-connectors.com/downloads/assembly-instructions/)].

1 2 3 4 5 6 7 8 9 10 11 12 13 14 15 16 17 18 19

G 6 W M - P 0 - 0 0 0 0

# BREAK-AWAY PLUG WITH SCREW-LOCK

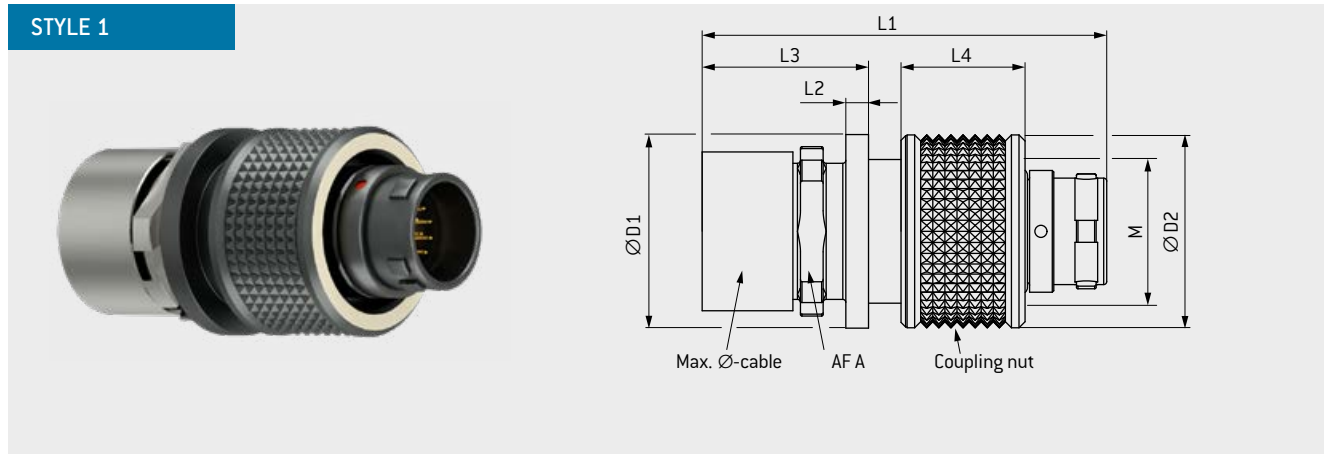

Size		L1	L2	L3	L4	D1	D2	AFA	M	Max. Ø-cable
		mm	mm	mm	mm	mm	mm	mm	mm	mm
00	<b>C</b>	25.5	1.0	10.1	8.1	9.8	10.5	6.5	7 × 0.5	5.0
0	<b>0</b>	26.8	1.5	11.0	8.2	12.8	12.8	9.0	10 × 0.5	6.5
1	<b>1</b>	27.8	1.5	12.0	8.3	14.8	15.2	11.0	12 × 0.5	8.0

### TECHNICAL DATA

- IP68 in relation to end device
- Contact configuration see page 36
- Cable assembly information see ODU instruction: 010.650.001.000.011 (available at [www.odu-connectors.com/downloads/assembly-instructions/](http://www.odu-connectors.com/downloads/assembly-instructions/)).

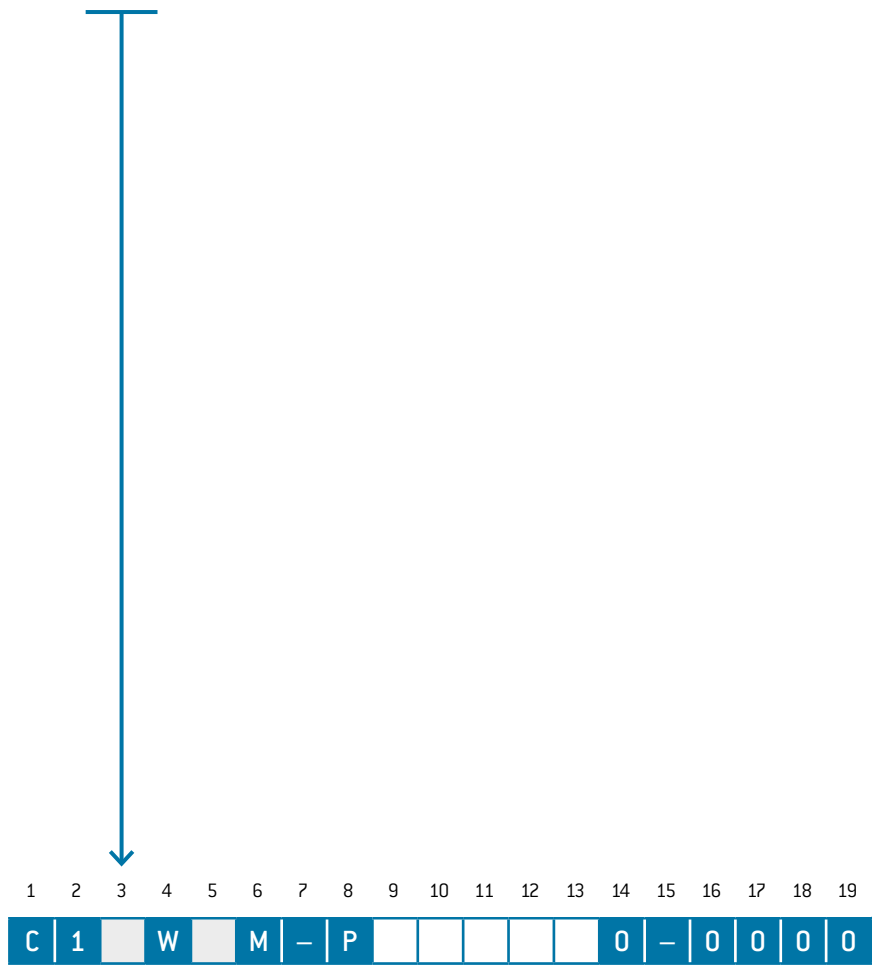

# IN-LINE RECEPTACLE FOR SCREW-LOCK

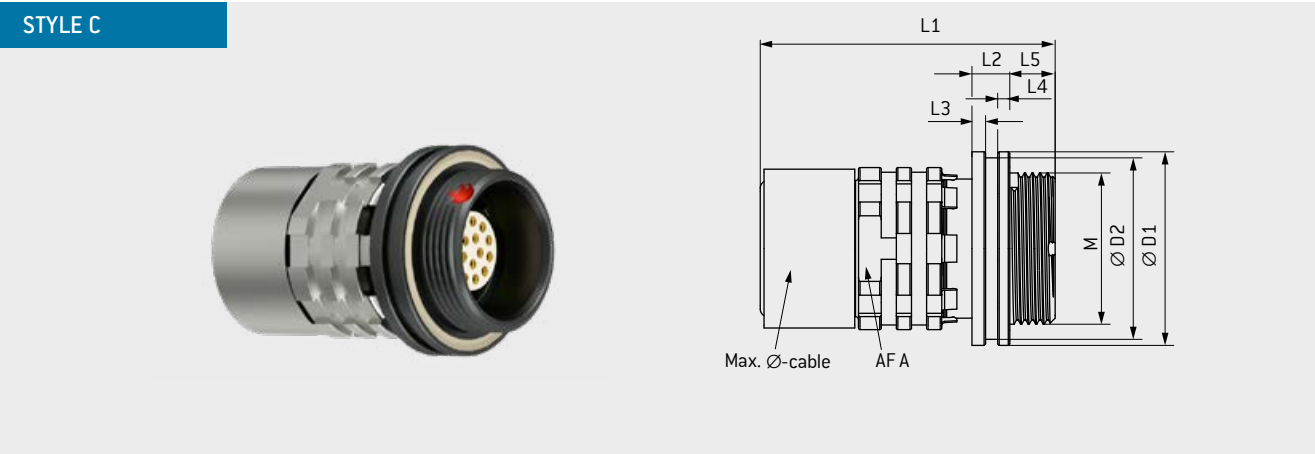

Size		L1	L2	L3	L4	L5	D1	D2	AFA	M	Max. Ø-cable <sup>1</sup>
		mm	mm	mm	mm	mm	mm	mm	mm	mm	mm
00	<b>C</b>	18.7	2.5	0.9	0.8	3.0	9.8	8.5	6.5	7 × 0.5	5.0
0	<b>0</b>	19.5	2.5	0.9	0.8	3.0	12.8	12.0	10	10 × 0.5	7.0
1	<b>1</b>	23.5	2.5	0.9	0.8	3.0	14.8	14.0	12	12 × 0.5	8.5

**TECHNICAL DATA**

- IP68 in relation to end device
- Contact configuration see page 36
- Cable assembly information see ODU instruction: 010.650.001.000.012 (available at [www.odu-connectors.com/downloads/assembly-instructions/](http://www.odu-connectors.com/downloads/assembly-instructions/)).



1 2 3 4 5 6 7 8 9 10 11 12 13 14 15 16 17 18 19  
**K C W M - P 0 - 0 0 0 0**

# PANEL MOUNT RECEPTACLE FOR SCREW-LOCK

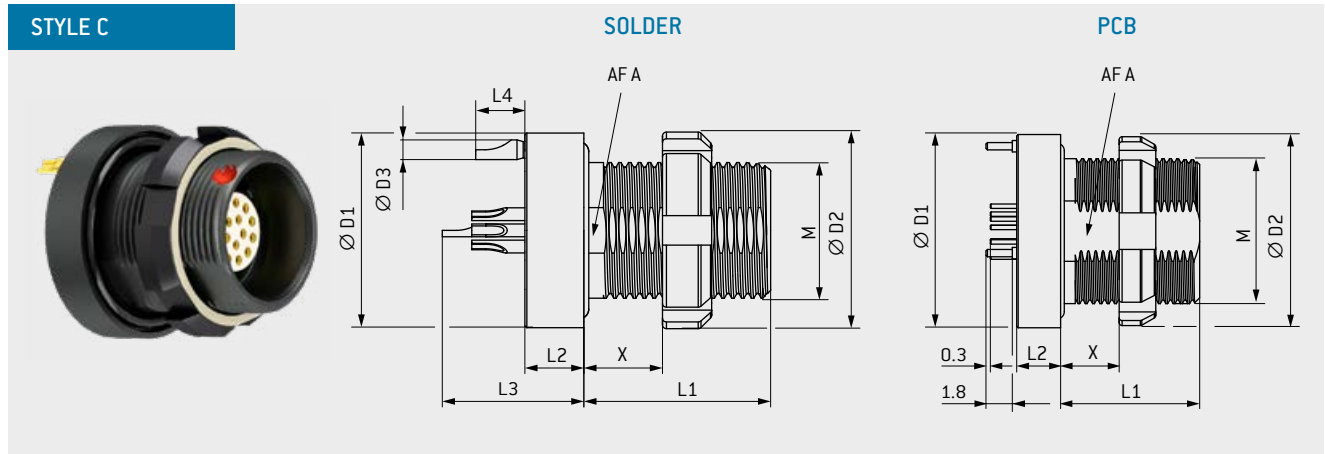

Size		L1 mm	L2 max. mm	L3 max. mm	L4 mm	X max. mm	D1 mm	D2 mm	D3 mm	AFA mm	M mm	Panel cut out	
												AF	Ø
00	<b>C</b>	9.5	3.0	7.2	2.5	4.0	9.9	10.0	1.0	6.5	7 × 0.5	6.6	7.1
0	<b>0</b>	9.5	3.0	7.2	2.5	4.0	13.2	12.9	1.0	9	10 × 0.5	9.1	10.1
1	<b>1</b>	9.5	3.0	8.7	2.5	4.0	15.3	14.9	1.0	11.5	12 × 0.5	11.6	12.1

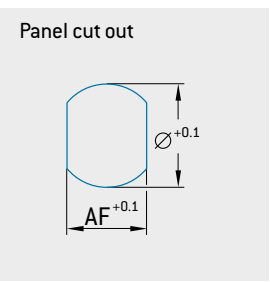

### TECHNICAL DATA

- IP68 in relation to end device, also in unmated condition
- Contact configuration see [page 36](#)
- PCB-Layouts see [page 37](#)

↓

1 2 3 4 5 6 7 8 9 10 11 12 13 14 15 16 17 18 19

**G | C | W | M | - | P | | | | | 0 | - | 0 | 0 | 0 | L**



# PANEL MOUNT RECEPTACLE FOR SCREW-LOCK

STYLE S

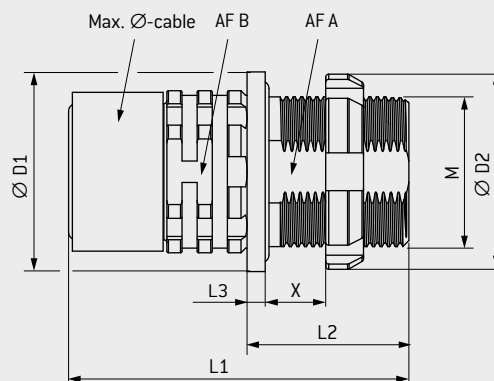

Size		L1	L2	L3	X max.	D1	D2	AF A	AF B	M	Panel cut out		Max. Ø-cable
		mm	mm	mm	mm	mm	mm	mm	mm	mm	AF	Ø	
00	<b>C</b>	22.0	10.7	1.2	4.0	9.9	10.0	6.5	8	7 × 0.5	6.6	7.1	5.0
0	<b>0</b>	22.5	10.7	1.2	4.0	13.2	12.9	9	10	10 × 0.5	9.1	10.1	7.0
1	<b>1</b>	26.5	10.7	1.5	4.0	15.3	14.9	11.5	12	12 × 0.5	11.6	12.1	8.5

Panel cut out

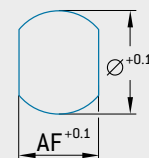

TECHNICAL DATA

- IP 68 in relation to end device, also in unmated condition
- Contact configuration see page 36
- Cable assembly information see ODU instruction: 010.650.001.000.013 (available at [www.odu-connectors.com/downloads/assembly-instructions/](http://www.odu-connectors.com/downloads/assembly-instructions/)).

1 2 3 4 5 6 7 8 9 10 11 12 13 14 15 16 17 18 19

G | S | W | M | - | P | | | | | 0 | - | 0 | 0 | 0 | 0

# FACTORY-TERMINATED FLEX ASSEMBLIES

## TERMINATION PC-BOARDS

ODU AMC® High-Density device components can be supplied for direct attachment to the board or as rigid-flex-solution. The solder process is tested and suitable for all available inserts.

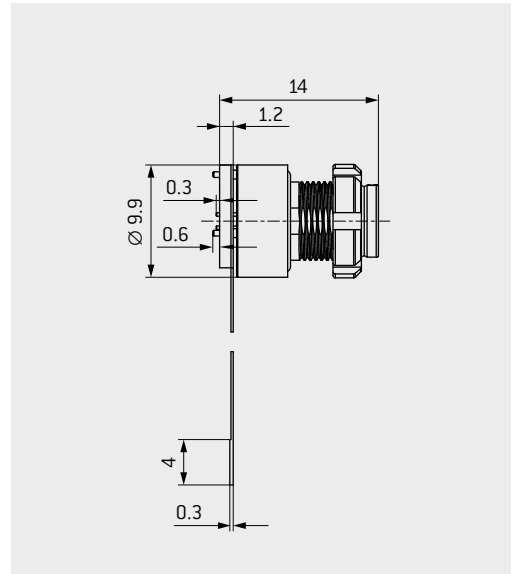
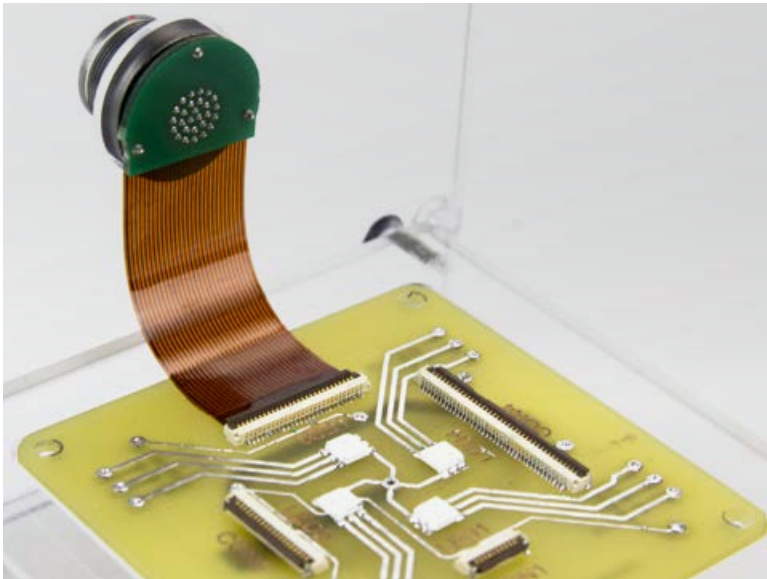

Size	Partnumber	AMC® High-Density Connector (Included)	Number of contacts	Connector coding	Suitable for
00	C00.71C.100.040.001	GKCWAM-P04UB00-000L	04	A	
	C00.71C.100.070.001	GKCWAM-P07UB00-000L	07	A	
0	C00.701.100.120.001	GKOWCM-P12UM00-000L	12	C	USB® 3.2 Gen 1 × 1 + Power <sup>1</sup>
	C00.701.100.160.001	GKOWAM-P16UB00-000L	16	A	
	C00.701.100.160.004	GKOWBM-P16UB00-000L	16	B	
1	C00.711.100.270.001	GK1WAM-P27UB00-000L	27	A	

Additional lengths, configurations and codings available on request. Contact ODU for more information. Flex is designed to work with suitable ZIF connector (not supplied). Contact ODU for more information.

<sup>1</sup> For data transmission protocols, please refer to page [2](#).

# CODING OPTIONS

# HOUSING MATERIAL

	Receptacle front view	Color coding	Color
A			Light brown (Standard)
B			Red
C			Blue
D			Green

	Housing Material
M	Brass EN-12164 Ruthenium over Ni

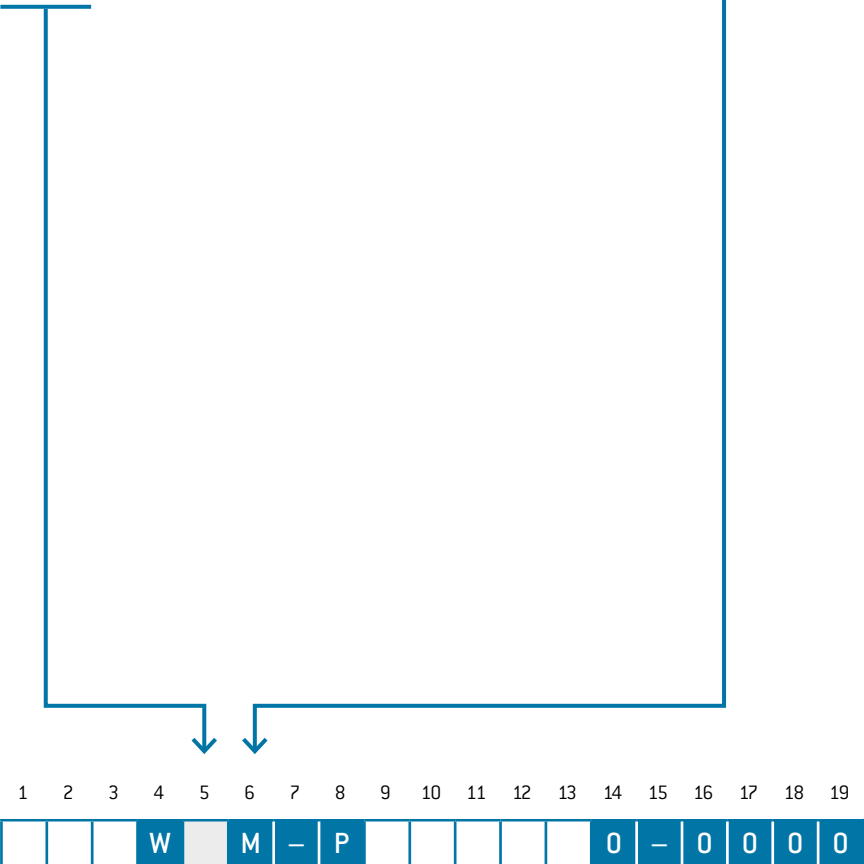

# CONTACT CONFIGURATIONS (SIZE 00)

Number of contacts <sup>1</sup>		Available connector styles					Contact type		Part number key				Contact diameter mm	Contact current recommend <sup>2</sup> A	Test voltage <sup>3</sup> VDC	Termination diameter mm	Termination cross section	
								Termination									AWG	mm <sup>2</sup>
0	2	K1	G6			GS	Socket	Solder	W	C	E	0	0.5	3	1.200	–	24	0.25
				GK	GC			Print/PCB	U	C	0	0				0.3	–	–
		A1	–	–	C1	–	Pin	Solder	X	C	E	0				–	24	0.25
0	4	K1	G6			GS	Socket	Solder	W	B	C	0	0.3	1	0.900	–	28	0.08
				GK	GC			Print/PCB	U	B	0	0				0.3	–	–
		A1	–	–	C1	–	Pin	Solder	X	B	C	0				–	28	0.08
0	7	K1	G6			GS	Socket	Solder	W	B	C	0	0.3	1	0.750	–	28	0.08
				GK	GC			Print/PCB	U	B	0	0				0.3	–	–
		A1	–	–	C1	–	Pin	Solder	X	B	C	0				–	28	0.08

## HIGH-SPEED INSERTS (OR SPECIFIC INSERTS FOR HIGH DATA TRANSMISSION RATES)

U	4	K1	G6	GK	GC	GS	Socket	Solder	W	B	M	0	2 × 0.3	1	0.750	–	28	0.08
		A1	–	–	C1	–			Pin	X	B	M	0	2 × 0.3		3	–	24
0	4			GK	GC		Socket	Print/PCB	U	B	0	0	0.3	1	0.750	0.3	–	–

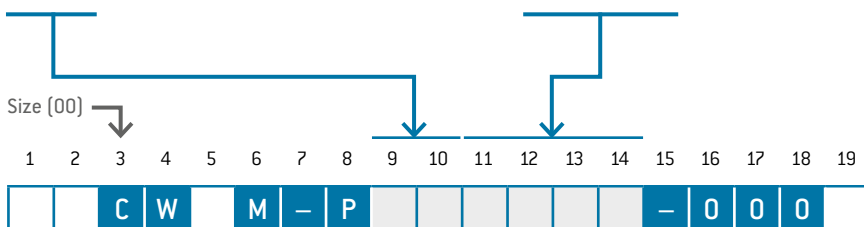

<sup>1</sup> Other contact configurations on request  
<sup>2</sup> Suitable wire (size and characteristics) considering the derating factor on page 55  
<sup>3</sup> Acc. to EIA-364-20F:2019-02, further information on voltage rating on page 56

# PCB LAYOUT PRINT CONTACTS SIZE 00

View on termination area		Data transmission protocols	Number of contacts	
Pin side	Socket side			
			2 pos.	
			4 pos.	
			7 pos.	
		USB® 2.0 <sup>4 5</sup>		
		USB® 2.0 <sup>4 5</sup>	High speed 4 pos.	

<sup>4</sup> Acc. Universal Serial Bus 3.2 Spec.:2017, further information on request.

<sup>5</sup> Concerning data transmission protocols please note page [2](#).

## HIGH-SPEED INSERTS

# CONTACT CONFIGURATIONS (SIZE 00 COAX)<sup>1</sup>

Number of contacts		Available connector styles				Contact type		Part number key				Contact diameter mm	Contact current recommend <sup>2</sup> A	Test voltage <sup>3</sup> VDC	Termination diameter mm	Termination cross section	
						Termination										AWG	mm <sup>2</sup>
K	1 <sup>1</sup>	-	G6	-	-	Socket	Solder	W	F	G	0	0.7	7	0.750	-	22	0.34
		A1	-	-	-	Pin		X	F	G	0						

<sup>1</sup> Impedance 50 Ohm  
VSWR < 1.25 up to 3 GHz with cable RD316  
<sup>2</sup> Suitable wire [size and characteristics] considering the derating factor on page [55](#)  
<sup>3</sup> Acc. to EIA-364-20F:2019-02, further information on voltage rating on page [56](#)

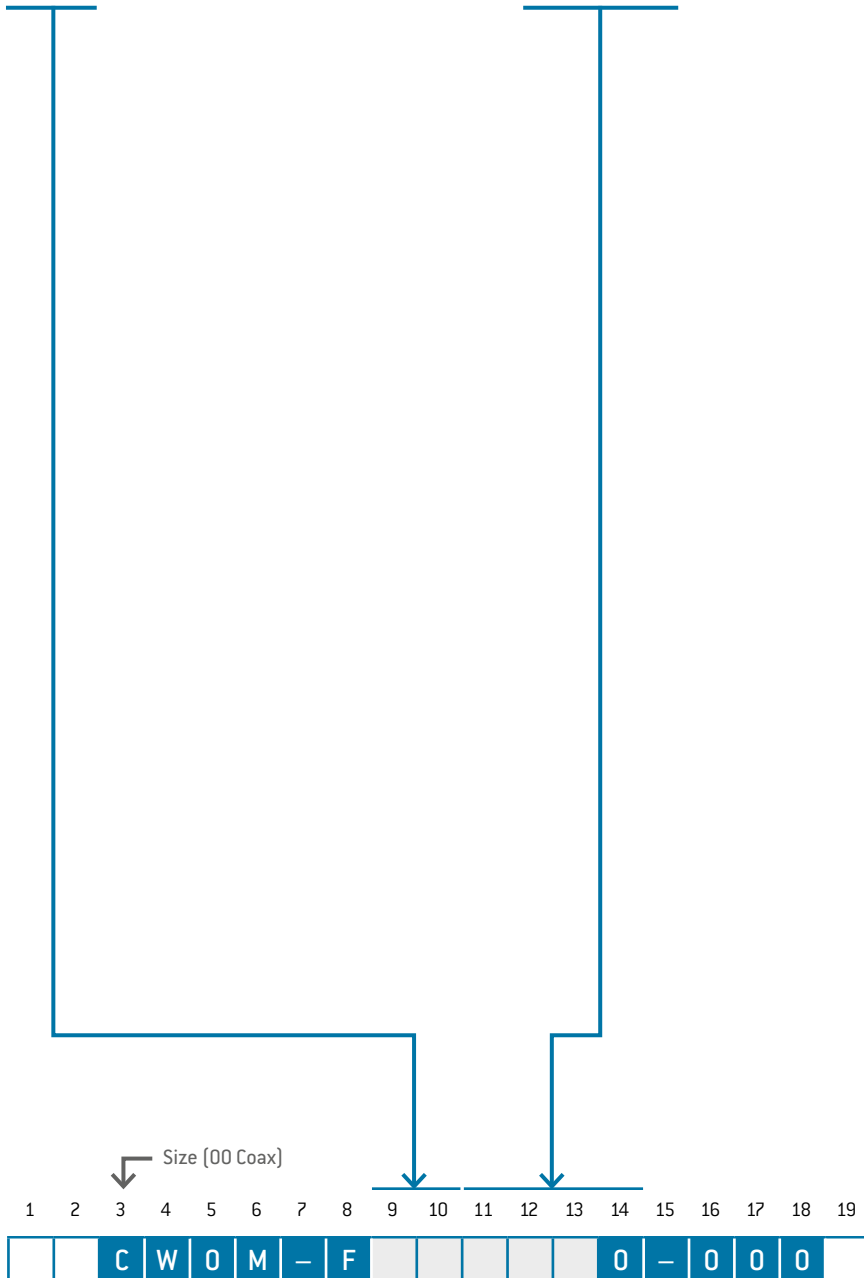

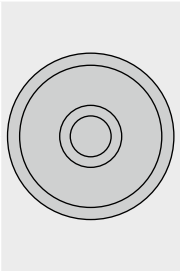
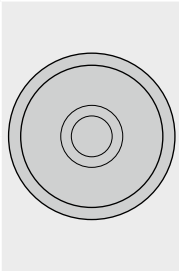
View on termination area		Data transmission protocols
Pin side	Socket side	
		

# CONTACT CONFIGURATIONS (SIZE 0)

Number of contacts <sup>1</sup>		Available connector styles				Contact type		Part number key				Contact diameter		Test voltage <sup>3</sup>		Termination diameter		Termination cross section	
							Termination					mm	A	VDC	mm	AWG	mm <sup>2</sup>		
D	8	K1	G6	–	GS	Socket	Solder	W	B	E	0	0.3	1	0.750	–	24	0.25		
		–	–	GK	–		GC	Print/PCB	U	B	0				0	0.3	–	–	
		A1	–	–	C1	–	Pin	Solder	X	B	E				0	–	24	0.25	
0	9	K1	G6	–	GS	Socket	Solder	W	M	M	0	3 × 0.3 6 × 0.7	1 5	0.750	–	28 22	0.08 0.38		
		–	–	–	–		GC	Print/PCB	U	M	0				0	0.3 0.8	–	–	
		A1	–	–	C1	–	Pin	Solder	X	M	M				0	–	28 22	0.08 0.38	
1	2	K1	G6	–	GS	Socket	Solder	W	M	M	0	10 × 0.3 2 × 0.7	1 5	0.750	–	28 22	0.08 0.38		
		–	–	–	–		GC	Print/PCB	U	M	0				0	0.3 0.8	–	–	
		A1	–	–	C1	–	Pin	Solder	X	M	M				0	–	28 22	0.08 0.38	
1	6	K1	G6	–	GS	Socket	Solder	W	B	C	0	0.3	1	0.750	–	28	0.08		
		–	–	–	–		GC	Print/PCB	U	B	0				0	0.3	–	–	
		A1	–	–	C1	–	Pin	Solder	X	B	C				0	–	28	0.08	

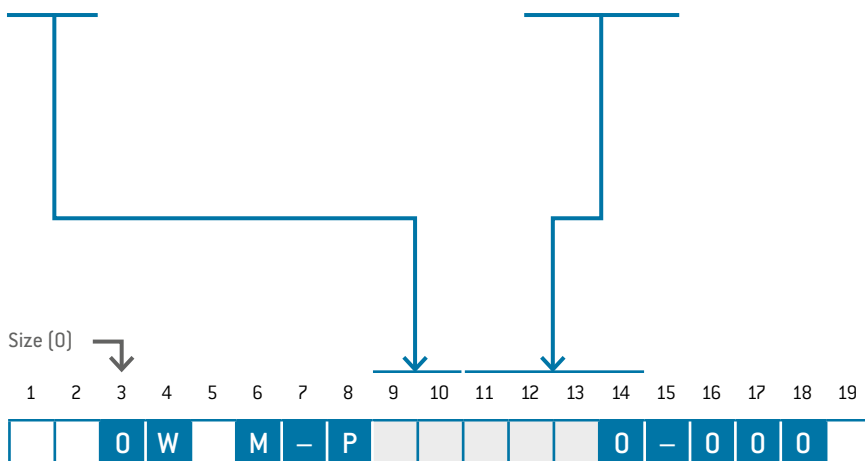

<sup>1</sup> Other contact configurations on request

<sup>2</sup> Suitable wire (size and characteristics) considering the derating factor on page 55

<sup>3</sup> Acc. to EIA-364-20F:2019-02, further information on voltage rating on page 56

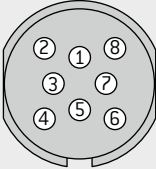
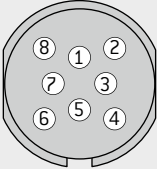
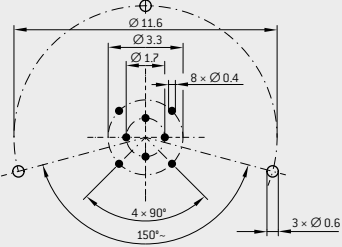
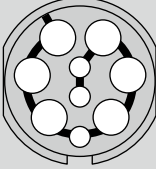
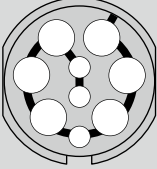
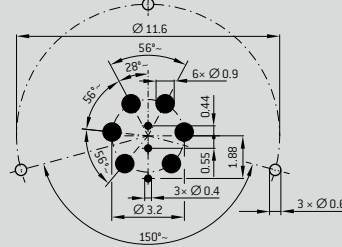
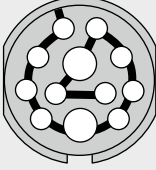
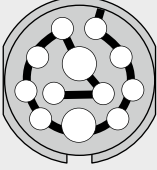
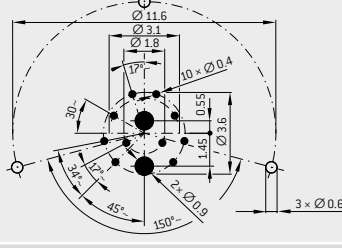
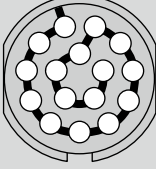
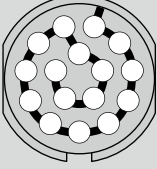
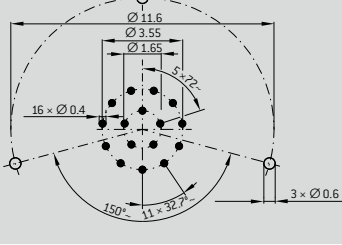

# PCB LAYOUT PRINT CONTACTS SIZE 0

View on termination area		Data transmission protocols	Number of contacts	
Pin side	Socket side			
		Ethernet Class E <sub>A</sub> <sup>5</sup> Channel up to 80m 10Gbit	8 pos.	
		USB <sup>®</sup> 2.0 <sup>4</sup> + Power	9 pos.	
		USB <sup>®</sup> 3.2 Gen 1 x 1 <sup>4</sup> + Power	12 pos.	
		Ethernet Typ CAT 5e <sup>5</sup> up to 1 Gbit	16 pos.	

<sup>4</sup> Concerning data transmission protocols please note page 2.  
<sup>5</sup> ISO / IEC 11801:2017, further information on request

# CONTACT CONFIGURATIONS (SIZE 1)

Number of contacts <sup>1</sup>		Available connector styles				Contact type		Part number key				Contact diameter		Contact current recommend <sup>2</sup>	Test voltage <sup>3</sup>	Termination diameter		Termination cross section	
							Termination					mm	A			VDC	mm	AWG	mm <sup>2</sup>
2	0	K1	G6	GK	GC	GS	Socket	Solder	W	M	M	0	16 × 0.3 4 × 0.7	1 5	0.750	–	28	0.08	
		Print/PCB	U					M	0	0	0.3	–				–			
		A1	–	–	C1	–	Pin	Solder	X	M	M	0				–	28	0.08	
2	7	K1	G6	GK	GC	GS	Socket	Solder	W	B	C	0	0.3	1	0.750	–	28	0.08	
		Print/PCB	U					B	0	0	0.3	–				–			
		A1	–	–	C1	–	Pin	Solder	X	B	C	0				–	28	0.08	

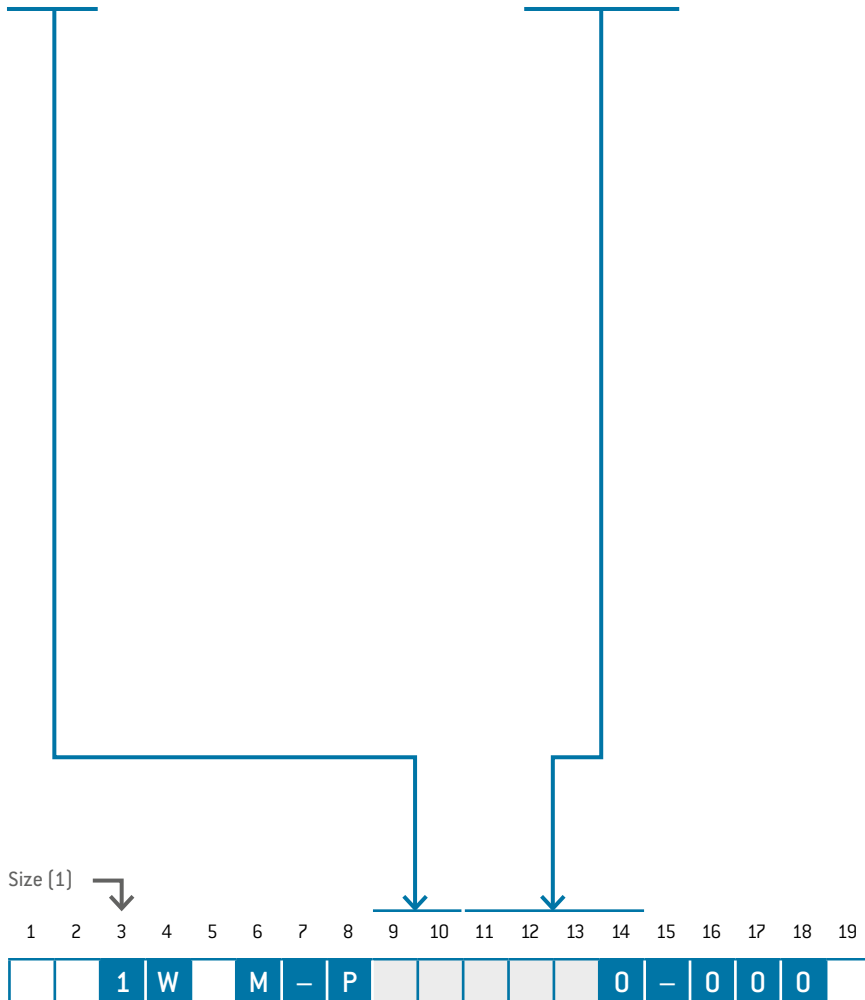

<sup>1</sup> Other contact configurations on request  
<sup>2</sup> Suitable wire (size and characteristics) considering the derating factor on page 55  
<sup>3</sup> Acc. to EIA-364-20F:2019-02, further information on voltage rating on page 56

# PCB LAYOUT PRINT CONTACTS SIZE 1

View on termination area		Data transmission protocols	Number of contacts	
Pin side	Socket side			
			20 pos.	
		HDMI® <sup>4</sup>	27 pos.	

<sup>4</sup> Concerning data transmission protocols please note page [2](#).

# PROTECTIVE CAPS

## FOR RECEPTACLES AND IN-LINE RECEPTACLES

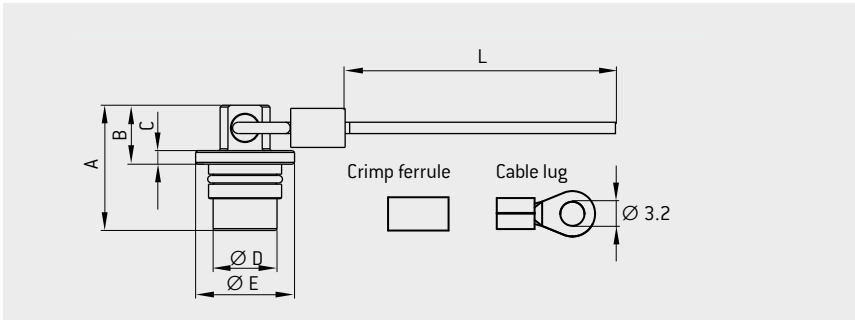

Size	Part number	Dimensions in mm					
		A	B	C	D	E	L
00	713.650.097.002.359	13.8	6.5	1.5	4.5	8.5	200
0	700.650.097.002.359	13.8	6.5	1.5	7.04	10.9	200
1	701.650.097.002.359	13.8	6.5	1.5	9.02	13.5	200

Crimp ferrule and lug are included.

## FOR PLUGS

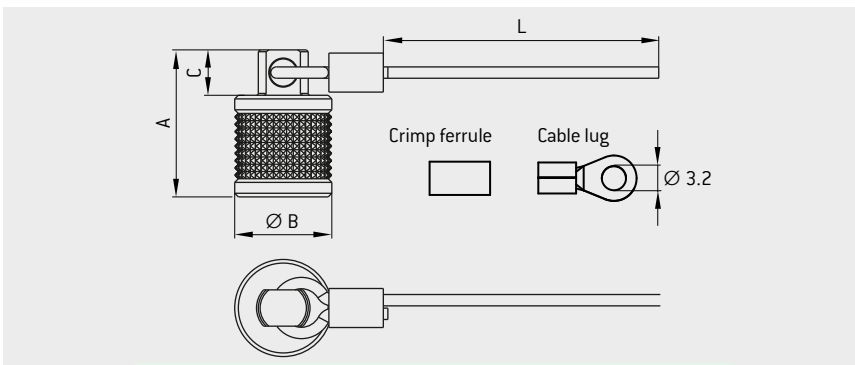

Size	Part number	Dimensions in mm			
		A	B	C	D
00	713.650.097.001.359	16.2	8.6	5	200
0	700.650.097.001.359	16.2	10.7	5	200
1	701.650.097.001.359	16.2	13.5	5	200

Crimp ferrule and lug are included.

Assembly information including tools see ODU instruction 010.650.001.000.003 [available at [www.odu-connectors.com/downloads](http://www.odu-connectors.com/downloads)].

## CUSTOM PARTS



### 40 POSITIONS / SIZE 1.5

- Ø 16.8 mm and a panel cut-out of Ø 14 mm
- Special cable assembly and potting needed



### ROBUST, MINIATURE, LOW SPACE

- Miniature connector
- Reduced outside dimension Ø 6.5 mm



### MINIATURE COAX CONNECTOR WITH SCREW LOCKING

- Cable assembly straight and right-angle
- Watertight



### ODU AMC® HIGH-DENSITY WITH CUSTOMIZED CABLE ASSEMBLY

- Space saving cable assembly and overmolding



### CUSTOMIZED LOW PROFILE SOLUTION

- Very small receptacle with chrome surface
- Plug with special customized design
- Very space saving overmolding and cable assembly
- Space saving 90° overmolding and cable assembly



- Space saving 90° cable assembly and overmolding
- Max. 6 positions

# ASSEMBLY AND CRIMP TOOLS

## CRIMP TOOL



PART NUMBER HAND CRIMP TOOL (ALL SIZES)  
080.000.026.000.000

### CRIMP DIES

Size	Part number
00 (C)	080.000.026.713.001
0	080.000.026.701.000
1	080.000.026.715.000

## CRIMP TOOL FOR CAPS

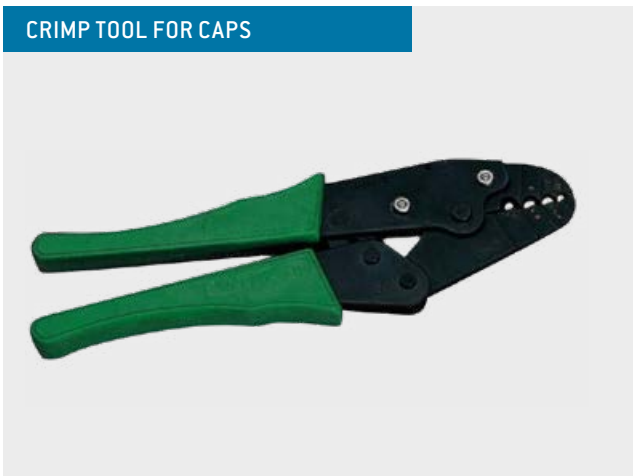

PART NUMBER HAND CRIMP TOOL (ALL SIZES)  
080.000.061.000.000

### CRIMP RANGE

Part	Tool adjustment
Cable lug	0.25 – 1.5
Crimp ferrule	0.25 – 1.5

## BAND-IT BANDS



PART NUMBER HAND CRIMP TOOL (ALL SIZES)  
080.000.058.000.000

PART NUMBER TIE-DEX MICRO BAND (ALL SIZES)  
921.000.004.000.248

To connect the shielding with the crimp adapter, use a [Tie-Dex Micro Band](#).

# ASSEMBLY AND CRIMP TOOLS

## NUTDRIVER FOR SLOTTED NUT

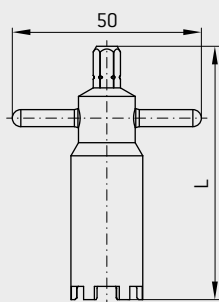

Size	Part number	L	Hex drive	Torque Nm
00 (C)	713.098.001.000.010	57	6.3 / 6.35	0.5
0	700.098.005.000.010	59	6.3 / 6.35	1
1	700.098.001.000.010	57	6.3 / 6.35	1

## SPANN WRENCH

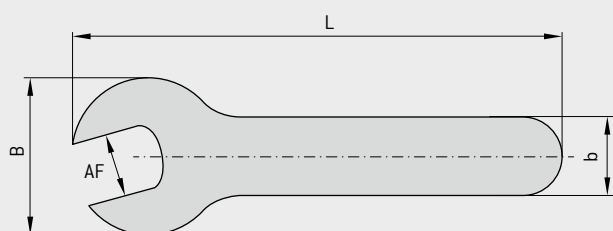

Size	Part number	Wrench size (AF)
00 (C)	598.700.001.001.000	8
0	598.700.001.002.000	10
1	598.700.001.003.000	12

## ASSEMBLY TOOL



Size	Part number
00 (C)	713.650.900.000.000
0	700.650.900.000.000
1	701.650.900.000.000

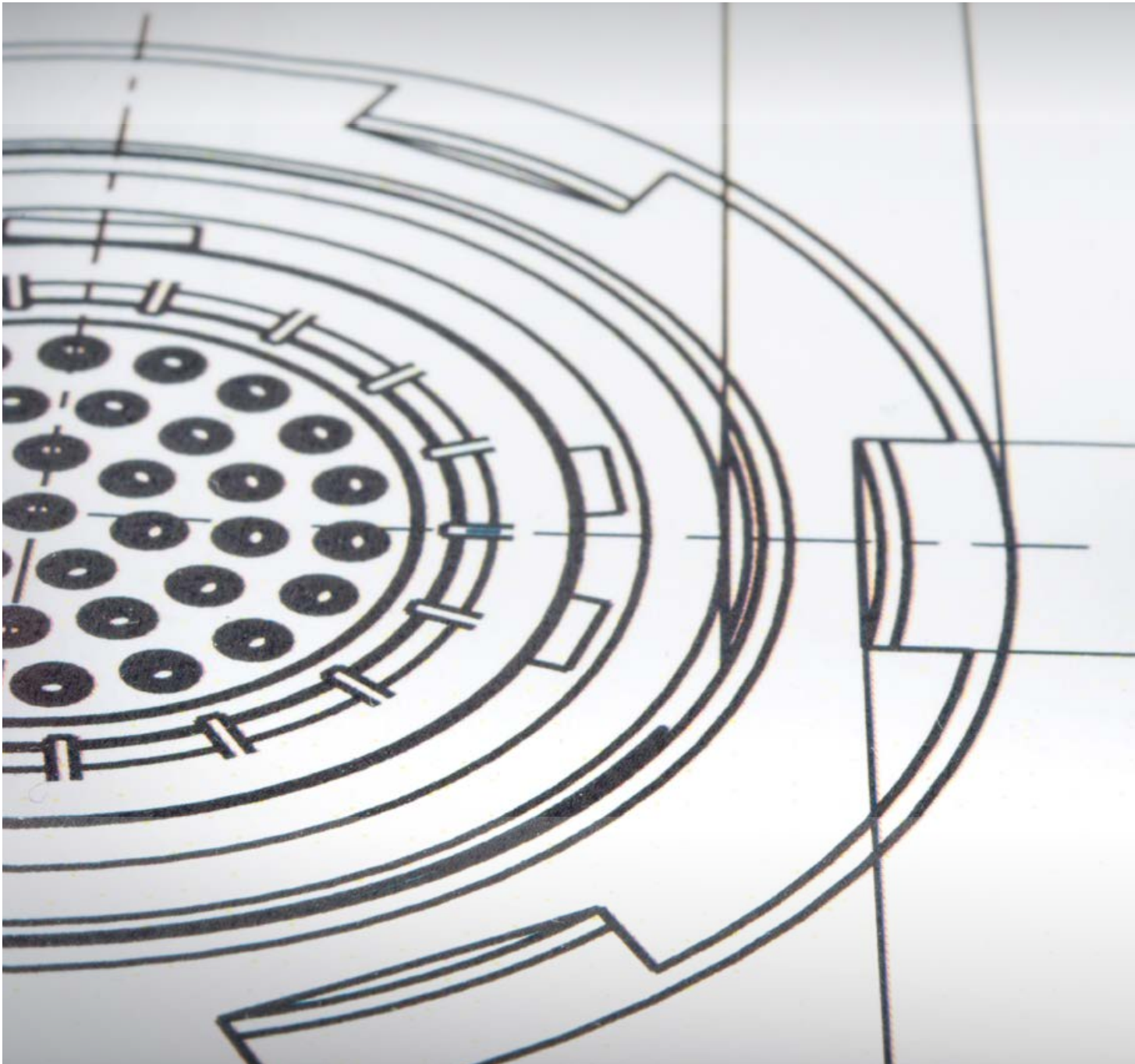

ODU AMC<sup>®</sup> HIGH-DENSITY





## TECHNICAL INFORMATION

ODU connectors ensure perfect and reliable transmission of power, signal, data and other media in a wide variety of applications.

Further information can be found on the following pages.

# TECHNICAL DATA

## ODU AMC<sup>®</sup> HIGH-DENSITY

### ENVIRONMENTAL AND TESTING

Type	Performance	Standard
Tightness	IPX8 / 20 m 120 min IPX9K	ISO 20653:2013-02 MIL-STD-810G:2008-10 512.5 ISO 20653: 2013-02
Sand and dust	Blowing sand and dust IP6KX (settling dust)	MIL-STD-810G:2008-10 510.5 Procedure I / II ISO 20653:2013-02
Operating temperature	-51°C up to +125°C <sup>1</sup>	IEC 60068-2-1:2007-05 IEC 60068-2-2:2007-10
Thermal shock	-51°C up to +125°C	MIL-STD-810G:2014-04 503.6
Humidity cyclic	85% r.h. up to 95% r.h., 28 °C up to 71 °C	EIA-364-31E:2017-04 Method V
Low pressure (rapid decompression)	59.1 kPa to 18.8 kPa	NATO-AECTP 300:2006-01 312 Procedure III
Low pressure (operation)	57.2 kPa, -55 °C	MIL-STD-810G:2008-10 500.5
Icing	Rime ice 6 mm	MIL-STD-810G:2008-10 521.3
Corrosion resistance	96 h salt mist, 5% salt solution, 35 °C (2 cycles – 24h spray / 24h dry)	MIL-STD-810G:2008-10 509.5
Mould growth	European fungus	IEC 60068-2-10:2005-06
Solar radiation	Ground level, procedure A	IEC 60068-2-5:2018-04

<sup>1</sup> Including temperature rise due to contact load.

### MECHANICAL DATA

Type	Performance	Standard
Mechanical endurance	5.000 mating cycles	IEC 60512-9-1:2010-03
Vibration	15 g (sine) 10 – 2,000 Hz No discontinuity > 1µs	EIA-364-28F:2011-02
Shock	50 g amplitude, half sine pulse of 6 ms, no discontinuity > 1 µs	EIA-364-27C:2011-06

### ELECTRICAL DATA

Type	Performance	Standard
Contact resistance (fig. 1) over 5,000 mating cycles	Contact diameter / resistance Ø 0.3 mm < 10 m0hm Ø 0.5 mm < 5 m0hm Ø 0.7 mm < 4 m0hm	IEC 60512-2-1: 2002-02
Shell resistance (fig. 2)	< 5 m0hm	IEC 60512-2-1: 2002-02
Insulation resistance	> 100 M0hm	IEC 60512-3-1: 2002-02
Shielding effectiveness	> 65 dB Connector pair A10W + K10W	IEC 62153-4-4: 2015-04

### MEASUREMENT POINTS

FIG. 1

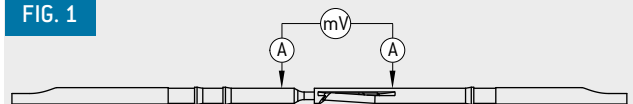
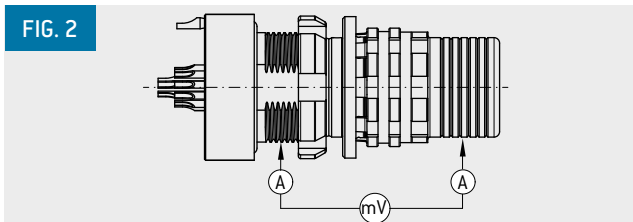

FIG. 2













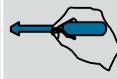

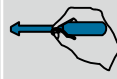



# MATERIAL AND SURFACE TREATMENT

Component	Material	Standard		Surface	Standard	Flammability
		EU	US			
Housing, backshell (style C1), outer sleeve	CuZn39Pb3	CW614N (2.0401)	C38500	Ruthenium over electroless nickel		
Grooved nut	CuZn39Pb3	CW614N (2.0401)	C38500	Black over electrodeposited nickel		
Backshell, grounding ring, press ring	CuZn39Pb3	CW614N (2.0401)	C38500	Electrodeposited nickel		
EMI-locking ring	CuBe2	CW102C (2.1248)	C17300	Gold over electroless nickel		
Crimp sleeve	CuZn38Pb1.5	CW608N (2.0371)	C35300	Electrodeposited nickel		
Outer press ring	CuZn39Pb3	CW614N (2.0401)	C38500	Black zinc-nickel over electrodeposited nickel		
Insulator	PEEK					UL94 (V0)
Insulator (for coax)	PTFE					UL94 (V0)
Pin contact	CuZn39Pb3	CW614N (2.0401)	C38500	1.27 µm gold over electrodeposited nickel	MIL-G-45204D	
Socket contact	CuSn4Pb4Zn4	CW456K (2.1076)	C54400	1.27 µm gold over electrodeposited nickel	MIL-G-45204D	
Half shells (for coax)	CuZn39Pb3	CW614N (2.0401)	C38500	Gold over electroless nickel		
O-Rings	FVMQ, FKM					
Potting	potting compound					UL94 (V0)
Overmolding material	TPU					UL94 (HB)
Shrink boots	Polyester-elastomer					acc. to VG95343

# INTERNATIONAL PROTECTION CLASSES

ISO 20653:2013 (VDE 0470-1:2014-09)

Code letters (International Protection)		First code number (Degrees of protection against access to hazardous parts respectively against solid foreign objects)		Second code number (Degrees of protection against water)		
IP		6		5		
Code no.	Protection against access to hazardous parts / Protection against ingress of solid foreign objects			Code no.	Protection against harmful effects due to the ingress of water	
0	No protection		No protection against contact / No protection against solid foreign objects	0	No protection against water	No protection against water
1	Protection against contact with the back of hand (no protection against intentional contact)		Test probe with diameter 50 mm shall not penetrate completely and maintain sufficient distance from hazardous parts.	1	Protection against dripping water	 Vertical drips shall not have any harmful effects or impair performance.
2	Protection against finger contact		Jointed test finger with diameter 12.5 mm may penetrate completely, but shall maintain a sufficient distance from hazardous parts.	2	Protection against dripping water (tilted)	 Vertical drips shall not have any harmful effects or impair performance when the enclosure is tilted at any angle up to 15° on either side of the vertical
3	Protection against penetration of tools (e.g. screwdrivers)		Test probe with diameter 2.5 mm, may penetrate completely, but shall maintain a sufficient distance from hazardous parts.	3	Protection against spray water	 Water spray at an angle up to 60° on either side of the vertical shall have no harmful effects or impair performance
4	Protection against granular foreign objects		Test probe with diameter 1.0 mm, may penetrate completely, but shall maintain a sufficient distance from hazardous parts	4	Protection against splashing water	 Water which splashes against the enclosure from any direction shall not have any harmful effects or impair performance
				4K	Protection against splashing water with increased pressure	 Water which splashes against the enclosure from any direction with increased pressure shall not have any harmful effects or impair performance
5K	Protection against dust		Dust shall only penetrate in quantities which do not impair performance and safety.	5	Protection against high-velocity water	 Water which is directed against the enclosure from any direction as a jet shall not have any harmful effects or impair performance
				6	Protection against powerful water jet	 Water which is directed against the enclosure from any direction as a strong jet shall not have any harmful effects or impair performance
6K	Protection against ingress of dust		Dust shall not penetrate	6K	Protection against strong high-velocity water with increased pressure	 Water which is directed against the enclosure from any direction as a strong jet with increased pressure shall not have any harmful effects or impair performance
				7	Protection against the effects of temporary immersion in water	 Water shall not penetrate in a quantity causing harmful effects or impair performance if the enclosure is immersed in water temporarily under specified pressure and time conditions
				8	Protection against the effects of continuous immersion in water	 Water shall not penetrate in a quantity causing harmful effects if the enclosure is continuously immersed in water under conditions which shall be specified by the manufacturer
				9K	Protection against water during high-pressure/steam-jet cleaning	 Water which is directed against the enclosure from any direction shall not have any harmful effects or impair performance

# PROTECTION OF ODU AMC<sup>®</sup> HIGH-DENSITY

IP RATING ACC. TO. ISO 20653:2013 // IMMERSION ACC. TO. MIL-STD-810H:2019 512.5 // SAND AND DUST ACC. TO. MIL-STD-810H:2019 510.5

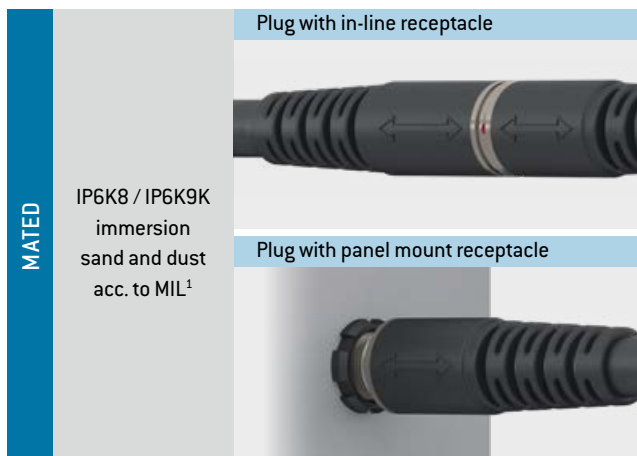
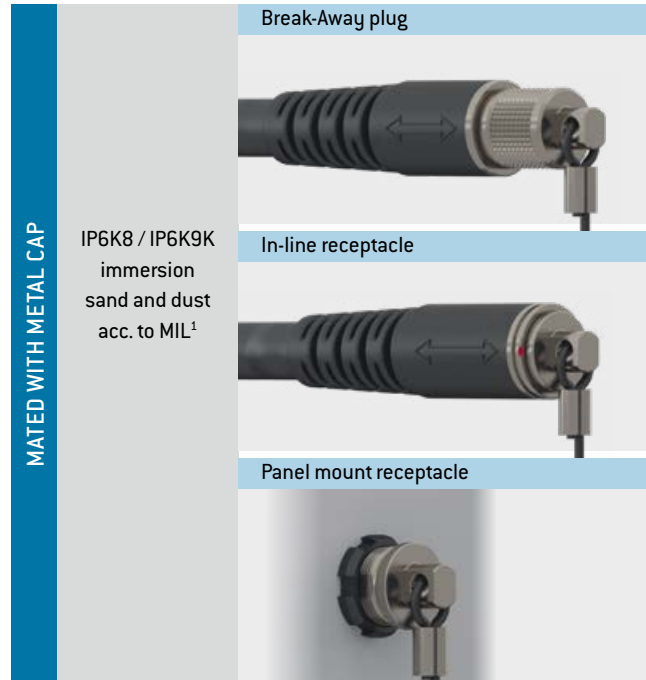
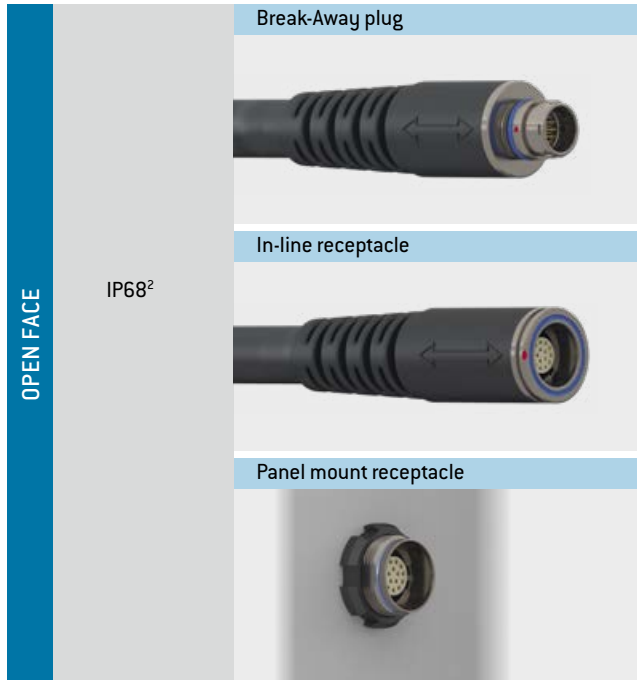

<sup>1</sup> Full protection  
<sup>2</sup> Contact area not IP protected

The protection is only assured when backshell potted during cable assembly, according to ODU AMC<sup>®</sup> High-Density assembly instructions.

# CONVERSIONS / AWG (AMERICAN WIRE GAUGE)

Circular wire					
AWG	Diameter		Cross-section mm <sup>2</sup>	Weight kg / km	Max. resistance Ω / km
	Inch	mm			
24 (1)	0.0197	0.5000	0.1960	1.830	91.20
24 (7/32)	0.0230	0.5850	0.2270	2.080	86.00
24 (19/36)	0.0252	0.6400	0.2400	2.160	83.30
26 (1)	0.1570	0.4000	0.1220	1.140	147.00
26 (7/34)	0.0189	0.4800	0.1400	1.290	140.00
26 (19/38)	0.0192	0.4870	0.1500	1.400	131.00
28 (1)	0.0126	0.3200	0.0800	0.716	231.00
28 (7/36)	0.0150	0.3810	0.0890	0.813	224.00
28 (19/40)	0.0151	0.3850	0.0950	0.931	207.00
30 (1)	0.0098	0.2500	0.0506	0.451	374.00
30 (7/38)	0.0115	0.2930	0.0550	0.519	354.00
30 (19/42)	0.0123	0.3120	0.0720	0.622	310.00
32 (1)	0.0080	0.2030	0.0320	0.289	561.00
32 (7/40)	0.0094	0.2400	0.0350	0.340	597.10
32 (19/44)	0.0100	0.2540	0.0440	0.356	492.00
34 (1)	0.0063	0.1600	0.0201	0.179	951.00
34 (7/42)	0.0083	0.2110	0.0266	0.113	1,491.00
36 (1)	0.0050	0.1270	0.0127	0.072	1,519.00
36 (7/44)	0.0064	0.1630	0.0161	0.130	1,322.00
38 (1)	0.0040	0.1000	0.0078	0.072	2,402.00
40 (1)	0.0031	0.0800	0.0050	0.043	3,878.60
42 (1)	0.0028	0.0700	0.0038	0.028	5,964.00
44 (1)	0.0021	0.0540	0.0023	0.018	8,660.00

Source: ASTM

The American Wire Gauge (AWG) is based on the principle that the cross-section of the wire changes by 26% from one gauge number to the next. The AWG numbers decrease as the wire diameter increases, while the AWG numbers increase as the wire diameter decreases. This only applies to solid wire.

However, stranded wire is predominately used in practice. This has the advantage of a longer service life under bending and vibration as well as greater flexibility in comparison with solid wire.

Stranded wires are made of multiple, smaller-gauge wires (higher AWG number). The stranded wire then receives the AWG numbers of a solid wire with the next closest cross-section to that of the stranded wire. In this case, the cross-section of the stranded wire refers to the sum of the copper cross-sections of the individual wires.

Accordingly, strands with the same AWG number but different numbers of wires differ in cross-section. For instance, an AWG 20 strand of 7 AWG 28 wires has a cross-section of 0.563 mm<sup>2</sup>, while an AWG 20 strand of 19 AWG 32 wires has a cross-section of 0.616 mm<sup>2</sup>.

# CURRENT LOAD OF TURNED CONTACTS

Nominal single contact current load for pin / slotted socket (nominal diameter 0.3 mm – 0.7 mm)

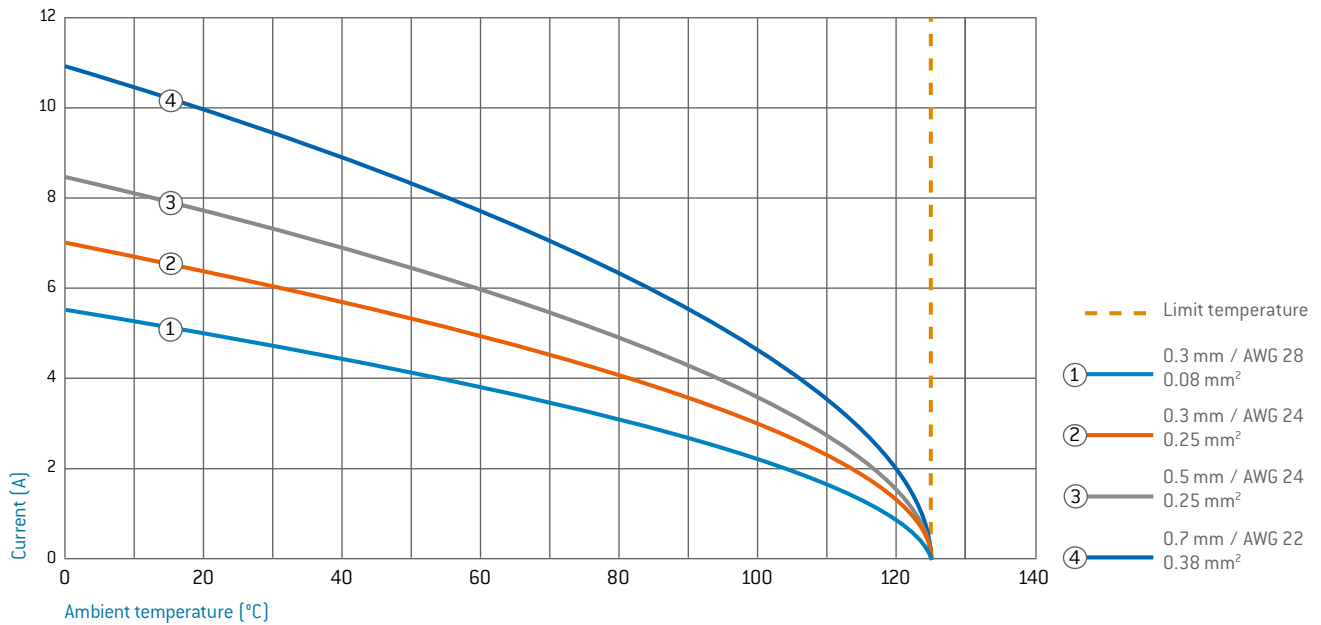

## UPPER LIMIT TEMPERATURE OF STANDARD CONTACTS: +125 °C

The wire cross-section shown in the legend was connected as test cable. In the case of multi-position connectors and cables, the heating is greater than it is with individual contacts. For that reason, it is calculated with a reduction factor.

For connectors, the reduction factors for multi-core cables pursuant to DIN VDE 0298-4:2013-06 are applied. The reduction factor is factored in at 5 live wires and up.

## DERATING CURVE

The corrected current-carrying capacity curve, derived from the base curve determined (0.8 × measured current). It factors in manufacturing tolerances as well as uncertainties in temperature measurement and measurement arrangement. See derating measurement method.

## DERATING FACTOR

Number of loaded wires	Derating factor
5	0.75
7	0.65
10	0.55
14	0.5
19	0.45
24	0.4

# EXPLANATIONS AND INFORMATION TO VOLTAGE RATINGS AND SAFETY REQUIREMENTS

## OPERATING VOLTAGE (RATED VOLTAGE)

All shown connectors and cable assemblies are rated to a safety extra low voltage (SELV) of less than 50 V AC / 75 V DC, according to IEC 61140:2016 (VDE 0140-1:2016) Protection against electric shock – Common aspects for installation and equipment. In case other standards rule a specific use of the connectors and cable assemblies, the application specific safety criteria shall be considered first. In this context, lower voltage ratings may be valid.

If a higher operating voltage is needed, please refer to chapter “Voltage rating according EIA-364-20F:2019”.

## VOLTAGE RATING ACCORDING

### EIA-364-20F:2019-02

### (TEST VOLTAGE / WITHSTANDING VOLTAGE)

#### WARNING:

Danger to life for operating voltages above 50 V AC / 120 V DC! The subsequently explained procedure according EIA-364-20F:2019 does not consider protection against electric shock. Suitable precautions (protective measures) such as touch protection, protective insulation, protective separation, protective earth conductor etc. must be implemented.

In case other standards rule a specific use of the connectivity solutions, the application specific safety criteria shall be considered first. This must be evaluated by the customer during the equipment engineering process.

For any advice on how the proper connectors and cable assemblies shall be chosen, please consult us and indicate the safety standard which your product has to meet.

### EIA-364-20F:2019-02

#### „WITHSTANDING VOLTAGE – TEST PROCEDURE FOR ELECTRICAL CONNECTOR, SOCKETS AND COAXIAL CONTACTS”

The test voltage values in the catalog are determined according to EIA-364-20F:2019-02 method A, test condition I (sea level up to 2000 m) „Withstanding Voltage – Test Procedure for Electrical connectors, Sockets and Coaxial Contacts“.

The test voltage represents the physical limit of the connector and is usually set at 75% of the break-down voltage.

According to EIA-364-20F:2019-02 and former MIL-STD-1344 method 3001 it is specified to set the operating voltage (rated voltage) to  $\frac{1}{3}$  of the test voltage acc. to EIA-364-20F:2019-02.

Example:

Breakdown voltage	$1000 \text{ V DC} \times 0.75 =$
Test voltage	$750 \text{ V DC} \times 0.33 =$
operating voltage	$250 \text{ V DC.}$



# TECHNICAL TERMS

## AMBIENT TEMPERATURE

Temperature of the air or other medium in which a piece of equipment is intended to be used in [IEC 44/709/CDV:2014 (VDE 0113-1:2014-10)].

## AWG

American Wire Gauge – see page [54](#)

## BASE CURVE

See page [55](#).

A current-carrying capacity curve metrologically determined according to the method described in IEC 60512-5-2:2002 (DIN EN 60512-5-2:2003-01) depending on the permissible limit temperature of the materials.

## CHEMICAL RESISTANCE

Many secondary processing procedures use adhesives, cleaning agents or other chemicals on our products. Contact with unsuitable chemicals may have an adverse effect on the mechanical and electrical properties of the insulation and housing materials which specified properties may not be able to withstand. Please observe our processing suggestions and technical instructions in this catalog.

## CLEARANCE DISTANCE

The shortest distance in the air between two conductive parts.

## CODING (ORIENTATION)

Arrangement with which differing polarization of otherwise identical connectors prevents interchangeability. This is a good idea if two or more identical connectors are attached to the same device (see also compatible connectors, see pages [35](#)).

## CONNECTORS

Also known as connectors without contact rating (COC): [IEC 61984:2008 (VDE 0627:2009-11)]. An element which enables electrical conductors to be connected and is intended to create and/or separate connections with a suitable counterpart.

## CONTACT RESISTANCE

Total resistance value measured from terminal to terminal. In this case, the resistance is significantly lower than the contact resistance. The specifications are average values.

## CONNECTORS WITHOUT BREAKING CAPACITY (COC)

Connectors which is not deemed to be engaged or disengaged in normal use when live or under load.

## CORES

Electrical conductor, solid wire or multi-wire strand, with insulation as well as any conductive layers. Cables or leads may have one or more cores.

## CREEPAGE DISTANCES

The shortest distance between two conductive parts along the surface of a solid insulation material. This factors in all elevations and recesses in the insulator, as long as defined minimum dimensions are on hand.

## CRIMP BARREL

A terminal sleeve which can accommodate one or more conductor and be crimped by a crimping tool.

## CRIMPING AREA

The specified area of the crimp barrel in which the crimp termination is executed by means of deforming or shaping the barrel under pressure around the conductor. See page [46](#).

## DEGREE OF POLLUTION

The effect of pollution is factored in as degree of pollution when measuring clearance and creepage distances. Four degrees of pollution are defined for the micro-environment: IEC 60664-1:2020-05 (VDE 0110-1:2008-0).

## DELIVERY FORM

Connectors can be delivered in assembled form or as individual parts.

## DERATING CURVE

The corrected current-carrying capacity curve, derived from the base curve determined ( $0.8 \times$  measured current). It factors in manufacturing tolerances as well as uncertainties in temperature measurement and measurement arrangement. See derating measurement method. See page [55](#).

## DERATING MEASUREMENT METHOD IEC 60512-5-2:2002 (DIN EN 60512-5-2:2003-01)

Measurement method to determine the current carrying capacity of connectors in consideration of the maximum permissible limit temperature (see page [55](#)).

## FIXED CONNECTORS

Intended for mounting on a fixed surface such as a frame, dock, device or wall (with ODU also receptacle or panel mounted plug).

# TECHNICAL TERMS

## FREE CONNECTORS

Intended for mounting on free ends of mobile leads and cables (with ODU also connectors, plugs, in-line receptacles).

## INSULATOR

Part of a connector which separates conductive parts with different potentials from one another; usually identical to the contact carrier.

## LOWERMOST LIMIT TEMPERATURE

The lowest permissible temperature at which a connector may be operated.

## MATING CYCLES

A mating cycle consists of one insertion and withdrawal action.

## MAX. CONTINUOUS CURRENT

The metrologically determined amperage at room temperature (approx. 20 °C) which increases the contact temperature to the limit temperature. The values specified in the catalog apply to either individual contacts or completely assembled inserts / modules, as indicated.

## NOMINAL SINGLE CONTACT CURRENT LOAD

The current-carrying capacity which each individual contact can be loaded with on its own (see page [55](#)).

## OPERATING TEMPERATURE FOR ODU AMC® HIGH-DENSITY

Range between the uppermost and lowermost temperature limits. –51 °C to +125 °C (see page [51](#)).

## PCB (A.K.A. “PRINTED CIRCUIT BOARD”)

A PCB is a carrier for electronic components. It serves the purposes of mechanical mounting and electrical connection.

## PCB TERMINATION

Production of a conductive connection between the PCB and an element in through-hole assembly, THT (through-hole technology).

## RATED VOLTAGE

The voltage which the manufacturer specifies for a connector and which the operating and performance features relate to.

## REDUCTION FACTOR

According to VDE 0298-4:2013-06, with connectors and cables over 5 contacts, the heating is greater than it is with individual contacts. For that reason, the aforementioned standard is calculated with a reduction factor.

## SOLDER CONNECTION (SOLDER TERMINATION)

Termination technology in which a molten additional metal (solder) with a lower melting point than the base materials to be connected is used to attach two metallic materials to one another.

## TERMINATION CROSS-SECTION

The specified cross-sections correspond to a “fine-wire” conductor structure pursuant to IEC 60228:2004 (VDE 0295:2005-09; Class 5) or a “fine-wire” conductor structure (7/19 wire) according to AWG (ASTM B 258:2018).

## TERMINATION TECHNOLOGIES

Methods for connecting the leads to the electro-mechanical element, such as solder-free connections pursuant to IEC 60352 (DIN EN 60352): crimp, screw connection etc. or soldering connection.

## TEST VOLTAGE

The voltage which a conductor can withstand under defined conditions without dielectric breakdown or flashover.

## TIGHTNESS ISO 20653:2013

See protection types on page [53](#).

## UPPERMOST LIMIT TEMPERATURE

The maximum permissible temperature at which a connector may be operated. It includes contact heating through current-carrying capacity.

## WIRE

Wires (solid conductors) are available with an insulator sleeve and / or electrical shielding. Cables or conductors may be made up of one or more wires.

---

# TECHNICAL TERMS

---

## GENERAL NOTE

The connectors listed in this catalog are intended for use in high voltage and frequency ranges. Suitable precautionary measures must be taken to ensure that people do not come into contact with live conductors during installation and operation.

All entries in this catalog were thoroughly reviewed before printing. ODU reserves the right to make changes based on the current state of knowledge without prior notice without being obliged to provide replacement deliveries or refinements of older designs.

---

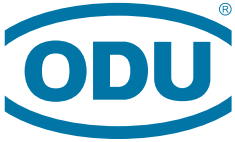

A PERFECT ALLIANCE.

## ODU GROUP WORLDWIDE

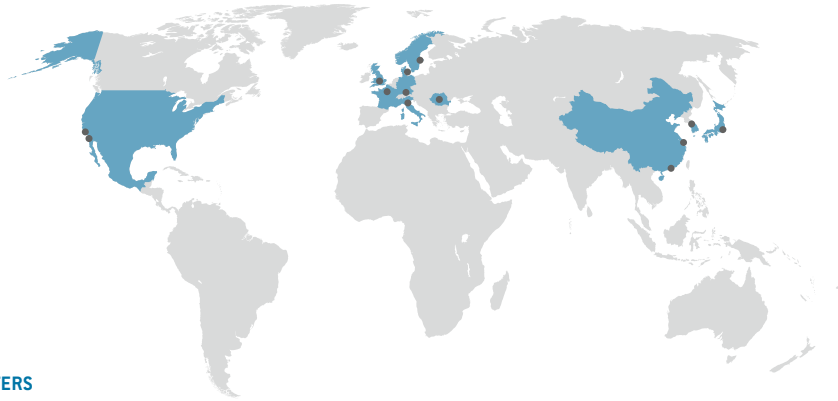

### HEADQUARTERS

#### ODU GmbH & Co. KG

Pregelstraße 11, 84453 Mühldorf a. Inn, Germany  
Phone: +49 8631 6156-0, Fax: +49 8631 6156-49, E-mail: sales@odu.de

### SALES LOCATIONS

#### ODU (Shanghai)

International Trading Co., Ltd.  
Phone: +86 21 58347828-0  
E-mail: sales@odu.com.cn  
www.odu.com.cn

#### ODU Italia S.R.L.

Phone: +39 331 8708847  
E-mail: sales@odu-italia.it  
www.odu-italia.it

#### ODU Scandinavia AB

Phone: +46 176 18262  
E-mail: sales@odu.se  
www.odu.se

#### ODU (HK) Trading Co., Ltd.

Phone: +852 5439-9036  
E-mail: sales@odu.hk  
www.odu.hk

#### ODU Japan K.K.

Phone: +81 3 6441 3210  
E-mail: sales@odu.co.jp  
www.odu.co.jp

#### ODU-UK Ltd.

Phone: +44 330 002 0640  
E-mail: sales@odu-uk.co.uk  
www.odu-uk.co.uk

#### ODU Denmark ApS

Phone: +45 2233 5335  
E-mail: sales@odu-denmark.dk  
www.odu-denmark.dk

#### ODU Korea Inc.

Phone: +82 2 6964 7181  
E-mail: sales@odu-korea.kr  
www.odu-korea.kr

#### ODU-USA Inc.

Phone: +1 805 484-0540  
E-mail: sales@odu-usa.com  
www.odu-usa.com

#### ODU-France SARL

Phone: +33 1 3935-4690  
E-mail: sales@odu.fr  
www.odu.fr

#### ODU Romania Manufacturing SRL

Phone: +40 269 704638  
E-mail: sales@odu-romania.ro  
www.odu-romania.ro

#### Further information and specialized representatives can be found at:

[www.odu-connectors.com/contact](http://www.odu-connectors.com/contact)

### PRODUCTION AND LOGISTICS SITES

Germany	Otto Dunkel GmbH
China	ODU (Shanghai) Connectors Manufacturing Co., Ltd.
Mexico	ODU Mexico Manufacturing S. de R.L. de C.V.
Romania	ODU Romania Manufacturing SRL
USA	ODU North American Logistics Inc.



Simply scan the QR code to download the entire publication.

All dimensions are in mm. Some figures are for illustrative purposes only. Subject to change without notice. Errors and omissions excepted. We reserve the right to change our products and their technical specifications at any time in the interest of technical improvement. This publication supersedes all prior publications. This publication is also available as a PDF file that can be downloaded from [www.odu-connectors.com](http://www.odu-connectors.com)

KOMMA Werbeagentur GmbH

ODU-AMC HIGH-DENSITY / C / 0321 / EN