

A PERFECT ALLIANCE.



ODU AMC[®]

Ruggedized miniature circular connector
with Easy-Clean function

EASY-CLEAN
BREAK-AWAY



ODU AMC[®] EASY-CLEAN

ODU AMC[®]

ODU AMC[®] HIGH-DENSITY

ODU THREADED CONNECTOR

ODU AMC®

FEATURES

- Low weight and compact design
- Easy handling
- Watertight
- Blind mateable
- Robust
- EMC shielding
- Robust mechanical and optical coding
- Resist all kinds of extremes like dust, temperature, humidity, corrosion, radiation and shock vibration

APPLICATIONS

- Communication systems (PTT, PRR)
 - Ruggedized computers and hand-helds
 - Power supply
 - Unmanned systems
 - Optical devices
 - Nightvision systems
 - Software defined radions
 - Defence and security
-



All shown connectors are according to IEC 61984:2008 (VDE 0627:2009); connectors without breaking capacity (COC).

ODU AMC® Easy-Clean is UL-listed under file E110586.

Issue: 2019-09

TABLE OF CONTENTS

Clickable page
numbers

THE ODU CORPORATE GROUP	<u>4</u>
PRODUCT INFORMATION	<u>11</u>
Ruggedized miniature circular connector	<u>12</u>
ODU AMC® – important Issues	<u>12</u>
ODU AMC® Easy-Clean connectors	<u>13</u>
Further products of the ODU Push-Pull connector series	<u>13</u>
Bit by bit to the perfect connection	<u>14</u>
CONFIGURATION GUIDELINE	<u>17</u>
ODU AMC® – EASY-CLEAN	<u>23</u>
Summary	<u>24</u>
Break-Away plug	<u>25</u>
Panel plug rear mount	<u>26</u>
In-line receptacle	<u>27</u>
Receptacles	<u>28</u>
Coding possibilities	<u>30</u>
Housing material	<u>30</u>
Contact configurations and PCB layouts	<u>32</u>
Protection caps	<u>38</u>
TECHNICAL INFORMATION	<u>41</u>
Technical data	<u>42</u>
International protection classes	<u>44</u>
Spring loaded contact	<u>45</u>
Watertightness	<u>46</u>
Current load – contacts	<u>48</u>
Operating voltage	<u>49</u>
Conversion / AWG	<u>50</u>
Technical terms	<u>51</u>

For assembly instructions please refer to our website: www.odu-connectors.com/downloads

A PERFECT ALLIANCE.

Creating connections, building alliances, collaborating into the future: Whether two technical components come together to form a unit or people come together to strive for great results – the key is to aspire to achieve superb results. This goal drives our work. **Perfect connections that inspire and deliver on the promises.**



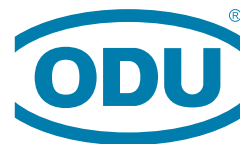

A PERFECT ALLIANCE.

” WORLDWIDE CUSTOMER PROXIMITY

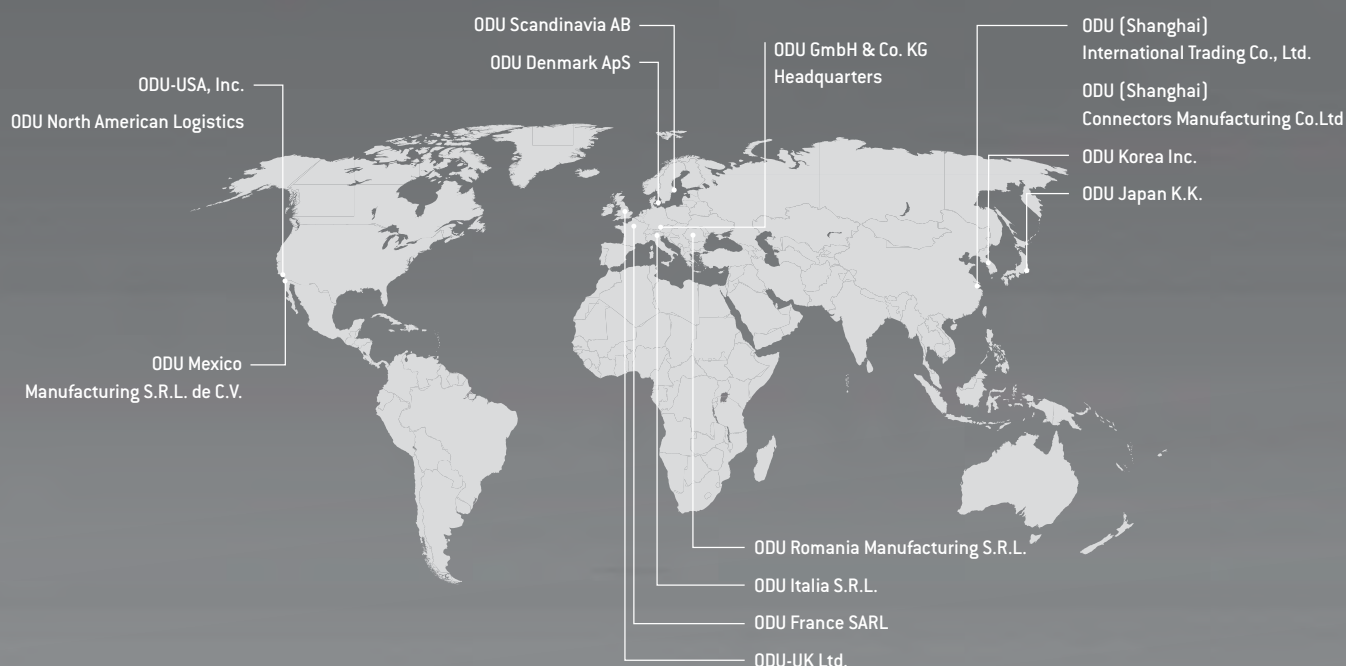

ODU GROUP OVERVIEW

- More than 75 years of experience in connector technology
- A turnover of € 200 million
- Over 2,300 employees worldwide
- Sales subsidiaries in China, Denmark, France, Germany, Italy, Japan, Korea, Sweden, UK and the US as well as 5 production and logistics sites
- All technologies under one roof: Design and development, machine tool and special machine construction, injection, stamping, turning, surface technology, assembly and cable assembly

CERTIFICATES & APPROVALS

- ISO 9001
- IATF 16949
- ISO 13485
- ISO 14001
- ISO 50001
- Wide range of UL, CSA, VG and VDE approvals
- UL Wiring Harnesses certified

For a complete list of our certifications and approvals, please visit our website.

INGENIOUS IDEAS

PERFECT SOLUTIONS

Product portfolio of ODU



ELECTRICAL CONTACTS

- Versatile connector technologies
- Outstanding reliability, lifetime and durability
- Up to 1 million mating cycles
- Current-carrying capacity of up to 2,400 A
- Rugged contact systems, suitable even for harsh environments
- Economical solutions for automatic processing
- Including cable assembly – complete solution



CIRCULAR CONNECTORS

- Circular connector series in robust metal or plastic housing
- Contacts for soldering, crimping and PCB termination
- Optional selectable Push-Pull locking or screw locking technology ensuring a secure connection at all times as well as easy to release Break-Away function
- 2 up to 55 contacts
- IP50 to IP69
- Autoclavable for medical applications
- Hybrid inserts for combined transmission
- Including cable assembly – complete solution



MODULAR CONNECTORS

- Application-specific hybrid interface
- For manual mating and automatic docking
- The highest packing density
- Flexible modular construction
- Multitude of data transmission modules
- For the transmission of signals, power, high current, high voltage, HF signals (coax), media, high-speed data and fiber optics
- Variety of locking options available
- Extremely durable – even under extreme conditions
- Mating cycles scalable as required from 10,000 to over 100,000 (1 million)
- Including cable assembly – complete solution

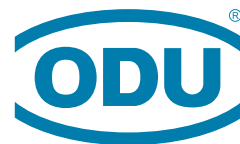

A PERFECT ALLIANCE.

” VERSATILE CONNECTOR SOLUTIONS FOR A WIDE RANGE OF APPLICATIONS



HEAVY DUTY CONNECTORS

- Extremely durable even under extreme / harsh environments
- High vibration resistance
- Up to 400 A (higher currents upon request)

PRINTED CIRCUIT BOARDS CONNECTORS



- Maximum flexibility in application designs
- High resilience and outstanding quality
- Including cable assembly – complete solution



APPLICATION AND CUSTOMER-SPECIFIC SOLUTIONS

- Contacts, connectors and cable assemblies for the highest technical requirements as well as special applications
- First-class implementation expertise
- High level of vertical manufacturing – all competences and key technologies under one roof
- Expert advice based on mutual partnership
- Short development and production paths



CABLE ASSEMBLY

- Complete systems from a single source based on years of expertise
- State-of-the-art production facilities with 100 % end testing
- Cleanroom production
- Overmolding in silicone, hot-melt and high-pressure procedures
- Customer-specific labeling
- Prototype, small series and high volume production
- Rapid prototyping

MORE THAN A CONNECTION

Our Know-How for your success



HIGH PERFORMANCE CONNECTOR TECHNOLOGY FOR DEMANDING KEY MARKETS

Customers rely on ODU technology wherever first-class, high-performance connector solutions are required. All our skills go into our products to ensure your success.

In addition to the top quality, reliable stability and maximum flexibility our products also stand for dynamics, reliability, safety, precision, efficiency and sustainability.

ODU – A PERFECT ALLIANCE.

CONNECTIONS THAT LIVE UP TO ANY REQUIREMENT

Contacts, connectors and integrated cable assembly solutions meeting the most demanding technical market requirements – ODU's connector solutions and value-added services are characterized by their exclusive focus on meeting the customer's needs.

- Precise implementation of application-specific requirements regarding design, functionality, cost and exclusivity
- Modified connector solutions derived from standard products
- One-to-one local expertise and fair, friendly consulting
- Short development and production paths

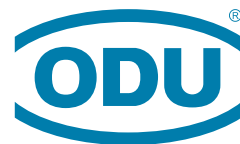

A PERFECT ALLIANCE.

” CROSS-INDUSTRY KNOW-HOW

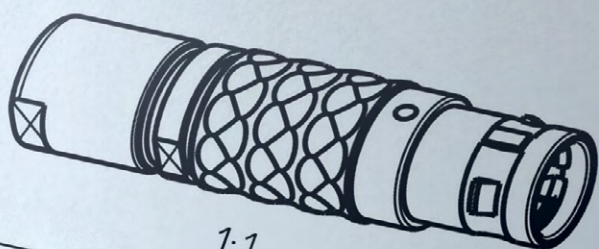

L_C-P03MSNO-9900	> 9.0 - 9.9 mm
L_C-P03MSNO-9200	> 8.0 - 9.2 mm
L_C-P03MSNO-8200	> 7.0 - 8.2 mm
L_C-P03MSNO-7200	> 6.0 - 7.2 mm
L_C-P03MSNO-6200	> 5.0 - 6.2 mm
L_C-P03MSNO-5200	> 4.0 - 5.2 mm
L_C-P03MSNO-4200	> 3.0 - 4.2 mm
L_C-P03MSNO-3200	> 2.0 - 3.2 mm
Kabel Ø cable Ø	



MEDICAL



TEST AND MEASUREMENT

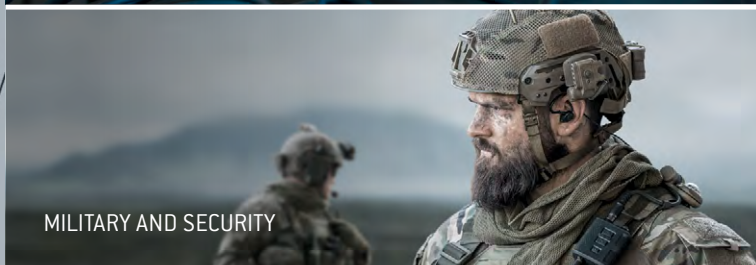

MILITARY AND SECURITY

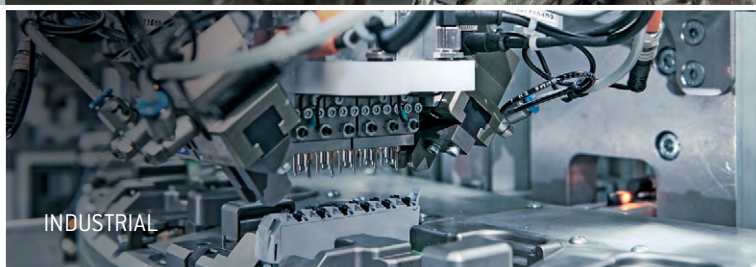

INDUSTRIAL



ENERGY



EMOBILITY

DEVELOPMENT OF CUSTOM SOLUTIONS

Demands that can't be pigeon-holed call for creative specialists who think outside the box. ODU offers the type of expertise that focuses solely on the specific requirements of our customers.

For every development order we get, we not only perform a thorough check to make sure it's feasible, we intensively incorporate our customers in the ongoing design process. This guarantees impressive, custom-fit final end products.



ODU AMC® EASY-CLEAN



PRODUCT INFORMATION

Ruggedized miniature circular connector	<u>12</u>
ODU AMC® – important issues.....	<u>12</u>
ODU AMC® Easy-Clean connectors	<u>13</u>
Further products of the ODU circular connector series.....	<u>13</u>
Bit by bit to the perfect connection.....	<u>14</u>

RUGGEDIZED MINIATURE CIRCULAR CONNECTOR – SAFE AND SECURE

ODU AMC® is a rugged miniature connector solutions for extreme environments. These connectors are designed with waterproof and hermetic sealing, robust mechanical and optical coding and EMC shielding. So the connectors are resist to all kind of extremes like dust, temperature, humidity, corrosion, radiation, shock vibration and torque.

Whether extreme environmental conditions or high mechanical stress: functionality under the most difficult conditions is a basic requirement. ODU connectors ensure a fast information flow with robust and reliable high-tech products. We provide connectors in places where the highest security level is the standard.

The ODU AMC® is available in a wide range of sizes and contact inserts. You can choose between different versions – Push-Pull, Break-Away, Easy-Clean and High-Density.

For additional information on ODU AMC® series see separate catalog.

VERSATILE CONFIGURATION OPTIONS

There are 6 sizes, 2 terminations types and a great variety of various contact inserts to choose from.



ODU AMC® – IMPORTANT ISSUES

VARIOUS SIZES

- Metal connector plug housing deliverable in 3 sizes
- Outer diameter 11.9 mm to 15.9 mm
- Number of contacts 4 to 19
- Protection class IP68 and IP69K are deliverable

APPLICATIONS AND MATERIALS

As standard the ODU AMC® use PEEK insulator material. ODU AMC® Connector plug housing are made of aluminium, nickel plated and then ruthenium plated (more information see page 43). The temperature of ODU AMC® range under general conditions of use runs from –51 °C to +125 °C (more information see page 43). Thanks to its rugged and versatility the ODU AMC® is used in a wide range of fields such as industrial electronics and defence & security, etc.

SYSTEM SOLUTION

Each connection needs its individual cable. Make no compromises when it comes to the quality of the complete connection system. ODU gives you the complete system solution from one source, without intermediary supplier.

- 100 % final inspections
- Production in clean room acc. to EN ISO 14644-1:2015 possible
- Automatic processes (cutting, stripping, attaching)
- Extrusion possible with a hot-melt and high-pressure / temperature process
- Ultrasound welding
- EMC-compatible assembly
- Application specific labelling
- Widest range of potting possibilities for sealed systems
- Extruded cable crossovers

ODU AMC® EASY-CLEAN CONNECTORS

	Coding	Size	No. of possible mechanical codings	Plug diameter in mm	Max. cable diameter in mm	Number of max. contacts	Solder	PCB	International protection class A ¹	International protection class B ²
	Pin and groove	0	4	11.9	5.5	7	●	●	up to IP69K	IP68
		1		13.9	6.5	16				
		1,5		15.9	8.0	19				

¹ International protection class in mated condition

² International protection class in unmated condition to the end device

FURTHER PRODUCTS OF THE ODU CIRCULAR CONNECTOR SERIES



- High speed data technology
- Secure Push-Pull locking and Break-Away function
- Contacts for solder and PCB termination
- Watertight protection class IP68 and IP69K

- Small and compact design
- High-contact density
- High-speed data technology
- Break-Away function
- Watertight protection class IP68

- High reliability for harsh environments
- Screw locking with “ratchet mechanism” (half turn locking)
- High vibration resistant
- Watertight protection class IP68
- More mate cycles than MIL spec. connectors

- Circular Push-Pull connector with metal housing
- Numberless combinations
- Watertight protection class IP50 und IP68

BIT BY BIT TO THE PERFECT CONNECTION

ODU offers you high-quality connectors and comprehensive service for the complete assembly. From connectors to watertight potting, we provide the complete system as an one-stop-shop solution.

BREAK-AWAY FUNCTION

The efficient Break-Away function allows for an easy establishment of connections within fractions of a second just like the Push-Pull locking. But furthermore it also features an emergency release which enables demating the connection when needed by pulling on the cable.

During mating, the connector's locking claws will lock into place in the corresponding grooves in the receptacle and form a dependable connection between the connector and the receptacle. The sloping shape of the locking claws ensures the "breaking away" of the connection when the connector or cable is pulled with a defined force.

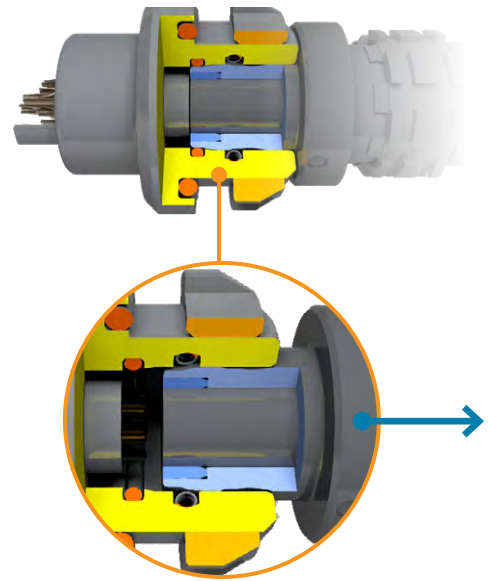

FOR YOUR NOTES

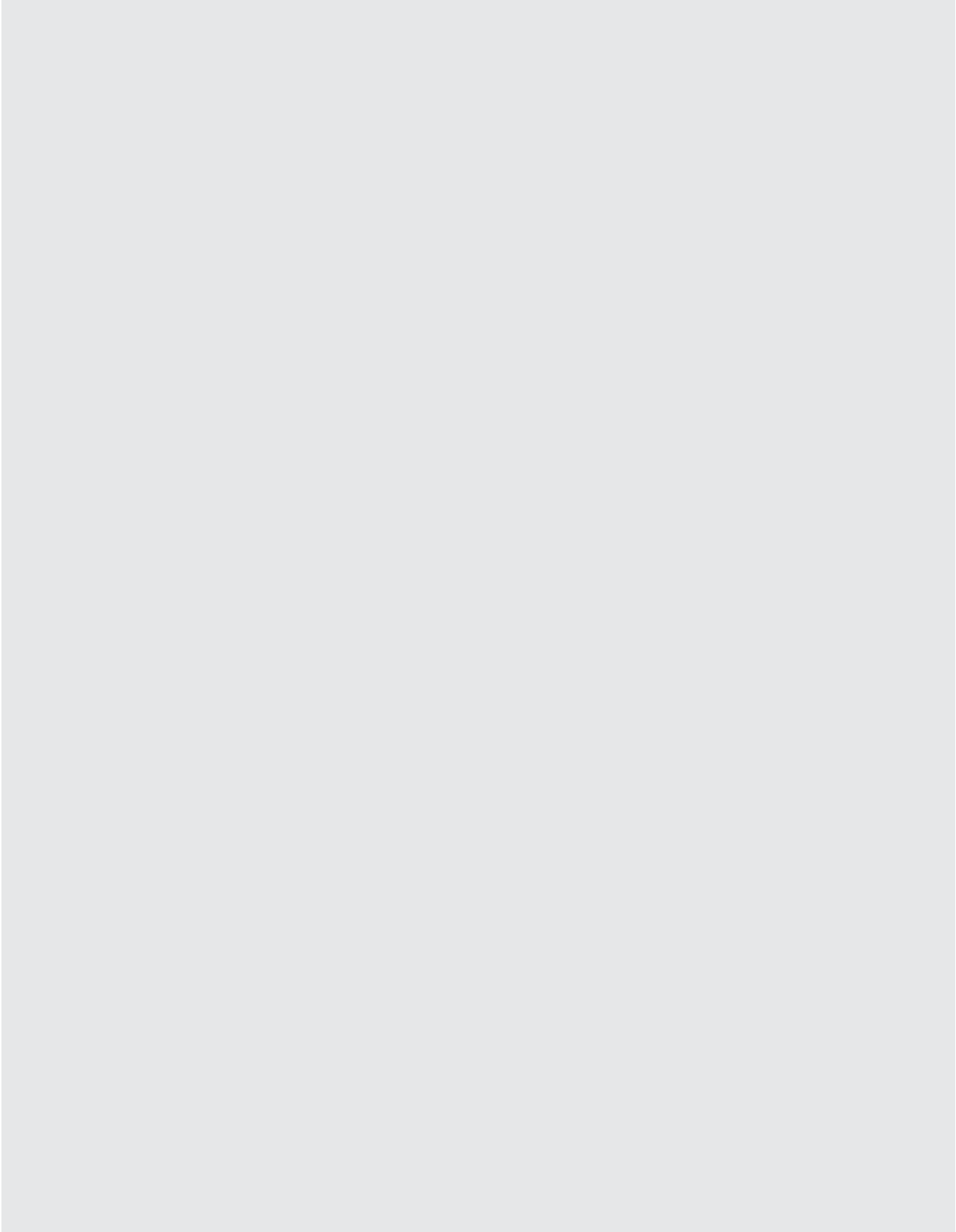



ODU AMC[®] EASY-CLEAN



CONFIGURATION GUIDELINE

Correct configuring – step by step

BIT BY BIT TO THE PERFECT CONNECTION

ODU offers you high-quality connectors and comprehensive service for the complete assembly. From connectors to watertight potting, we provide the complete system from a single source.

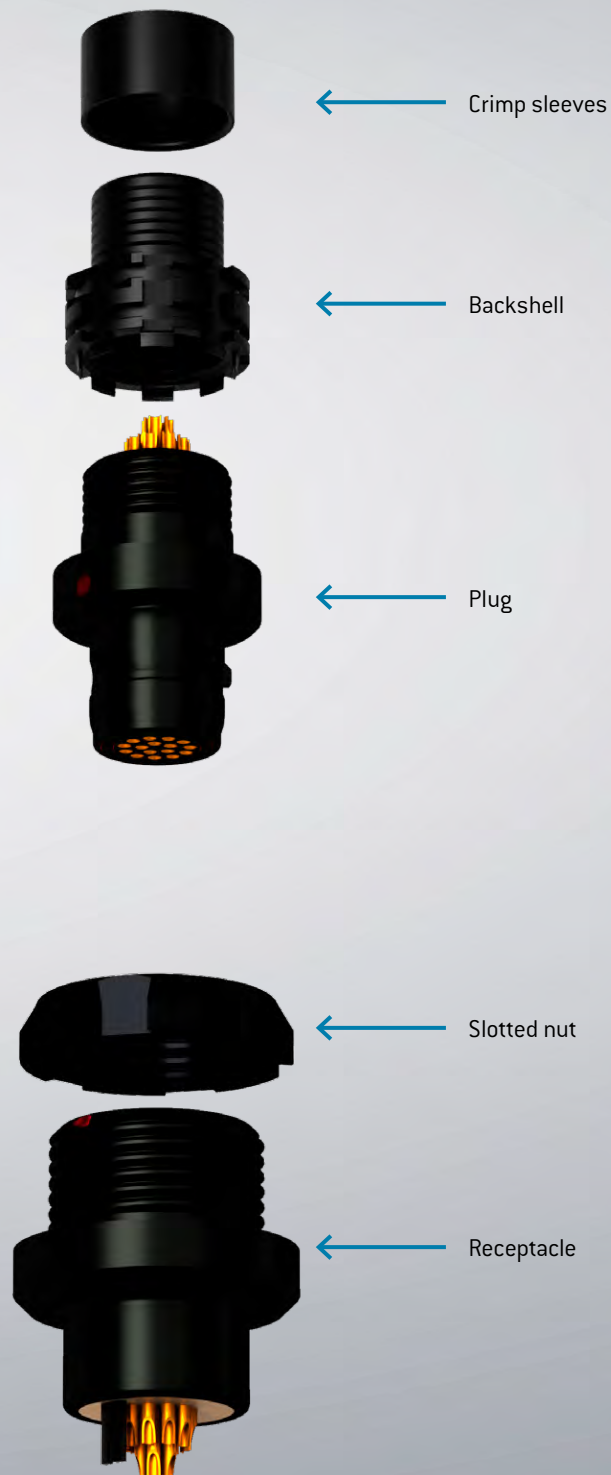

SAMPLE CONFIGURATION STEP BY STEP

The perfect product for you in just a few steps. These step-by-step instructions show you how to configure your own individual product with the ODU part number key based on a sample configuration.



Break-Away Plug / size 1 / AMC® series YR / coding A / connector plug housing ruthenium over aluminium / insulator PEEK / 16 contacts / solder flat contact/ contact diameter 0.6 / termination cross section AWG 26

STEP 1: SERIES (SEE POSITION 4)

1	2	3	4	5	6	7	8	9	10	11	12	13	14	15	16	17	18	19
			Y			-									-	R		0

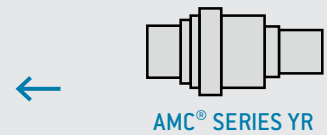

STEP 2: TYPE/STYLE (SEE POSITIONS 1, 2, 16, 17 AND 19)

PAGE 25 – 29

1	2	3	4	5	6	7	8	9	10	11	12	13	14	15	16	17	18	19	
A	1		Y			-									-	R	0	0	0

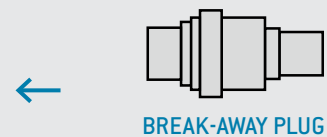

STEP 3: SIZE (SEE POSITION 3)

PAGE 32 – 37

1	2	3	4	5	6	7	8	9	10	11	12	13	14	15	16	17	18	19	
A	1	1	Y			-									-	R	0	0	0

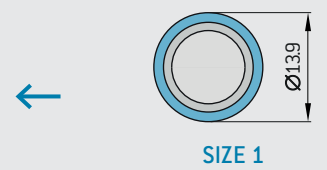

STEP 4: CODING (SEE POSITION 5)

PAGE 30

1	2	3	4	5	6	7	8	9	10	11	12	13	14	15	16	17	18	19	
A	1	1	Y	A		-									-	R	0	0	0

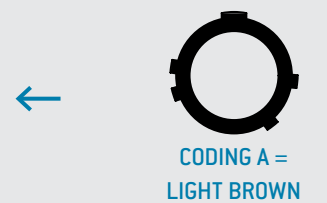

STEP 5: HOUSING MATERIAL (SEE POSITION 6)

PAGE 30

1	2	3	4	5	6	7	8	9	10	11	12	13	14	15	16	17	18	19	
A	1	1	Y	A	R	-									-	R	0	0	0



YOUR WAY TO AN INDIVIDUAL CONNECTION:

HOW TO CONFIGURE WITH THE PART NUMBER KEY

This shows you how ODU's part number key is composed. In the first part of the configuration, select the connector plug housing (such as style and size) of the connector. In the middle part of the part number key, you configure the contact insert and then the cable entry.

Type

A = Break-Away connector

G = Receptacle / panel mounted plug

K = In-line receptacle

Material insulator

(PEEK = standard)

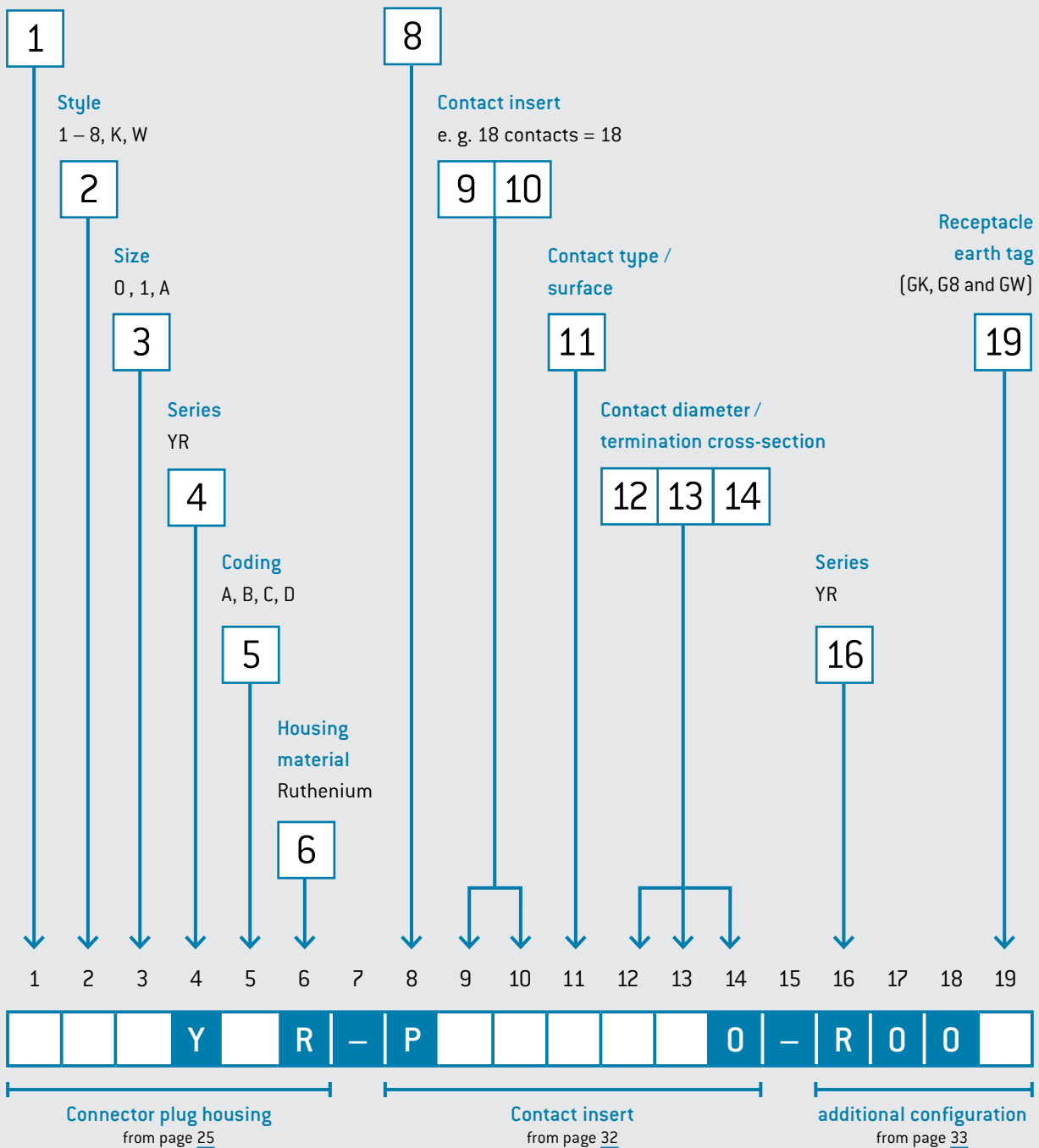

STEP 6: INSULATOR MATERIAL (SEE POSITION 8)

1	2	3	4	5	6	7	8	9	10	11	12	13	14	15	16	17	18	19
A	1	1	Y	A	R	-	P						0	-	R	0	0	0



STEP 7: CONTACT INSERT (SEE POSITIONS 9 AND 10)

PAGE 44 – 27

1	2	3	4	5	6	7	8	9	10	11	12	13	14	15	16	17	18	19
A	1	1	Y	A	R	-	P	1	6				0	-	R	0	0	0



STEP 8: CONTACT TYPE / SURFACE (SEE POSITION 11)

1	2	3	4	5	6	7	8	9	10	11	12	13	14	15	16	17	18	19
A	1	1	Y	A	R	-	P	1	6	W			0	-	R	0	0	0



STEP 9: CONTACT DIAMETER (SEE POSITION 12)

1	2	3	4	5	6	7	8	9	10	11	12	13	14	15	16	17	18	19
A	1	1	Y	A	R	-	P	1	6	W	D		0	-	R	0	0	0

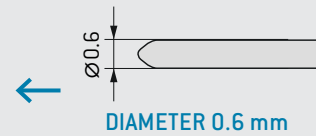

STEP 10: TERMINATION CROSS-SECTION (SEE POSITIONS 13)

1	2	3	4	5	6	7	8	9	10	11	12	13	14	15	16	17	18	19
A	1	1	Y	A	R	-	P	1	6	W	D	D	0	-	R	0	0	0

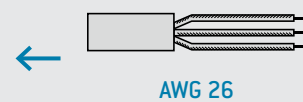



ODU AMC[®] EASY-CLEAN



ODU AMC[®] EASY-CLEAN

Summary	24
Break-Away plug	25
Panel plug rear mount	26
In-line receptacle	27
Receptacles	28
Coding possibilities	30
Housing material	30
Contact configurations and PCB layouts	32
Protection caps	38

SUMMARY ODU AMC® EASY-CLEAN

ODU AMC® EASY-Clean use pin and groove coding and additional to mechanical also optical color coding. These robust circular connectors can be configured in variety ways.

- mechanical coding over pin and groove
- 4 to 19 contacts
- up to 3 sizes
- protection class IP68 and IP69K available
- 5,000 mating cycles
- Spring loaded contacts for solder and print termination

IN-LINE RECEPTACLE

P. 27

K 1



BREAK-AWAY PLUG

P. 25

A 1



RECEPTACLES

P. 28

G K



PANEL PLUG REAR MOUNT

P. 26

G W



G 8



For assembly instructions please refer to our website: www.odu-connectors.com/downloads

BREAK-AWAY PLUG



Size		L1 mm	L2 mm	L3 mm	D1 mm	AFA mm	Max Ø-cable ¹ mm
0	0	23.5	3.0	15.0	11.9	9	5.5
1	1	26.9	3.5	18.4	13.9	11	6.5
1.5	A	27.5	3.5	18.5	15.9	12	8.0

TECHNICAL DATA

- Technical data see page 42
- Contact configuration see page 32
- Cable assembly information see ODU instruction 010.645.001.000.004 (available at www.odu-connectors.com/downloads/assembly-instructions/)

¹ Based on cable with one braided shield

↓

1 2 3 4 5 6 7 8 9 10 11 12 13 14 15 16 17 18 19

A | 1 | Y | R | - | P | | | | | | | 0 | - | R | 0 | 0 | 0

PANEL PLUG REAR MOUNT

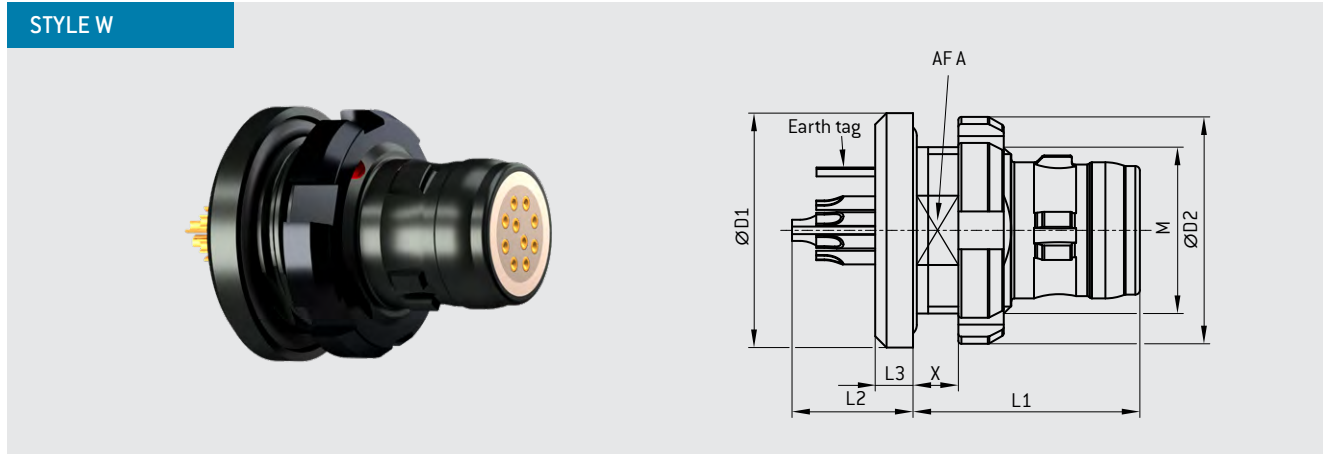

Size		L1 mm	L2 mm	L3 mm	X max mm	D1 mm	D2 mm	AFA mm	M mm	Panel cut out AF mm	Ø mm
0	0	15.0	6.4	2.5	3.0	13.2	12.8	9.2	10×0.5	9.3	10.1
1	1	15.0	8.0	2.5	3.5	15.5	15.0	10.0	11×0.75	10.1	11.1
1.5	A	16.5	9.7	4.0	3.5	17.5	17.9	13.0	14×0.75	13.1	14.1

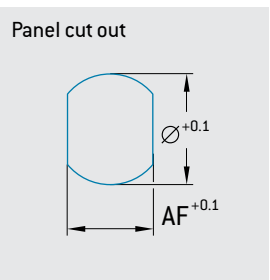

NUTDRIVER FOR SLOTTED NUT

Size	Number	Torque Nm
0	700.098.005.000.000	0.8
1	701.098.001.000.000	1.0
1.5 (A)	701.098.002.000.000	3.0

TECHNICAL DATA

- Technical data see page 42
- Contact configuration and PCB layout see page 32
- IP68, also in unmated condition

1 2 3 4 5 6 7 8 9 10 11 12 13 14 15 16 17 18 19

G W Y R - P O - R O O L

IN-LINE RECEPTACLE

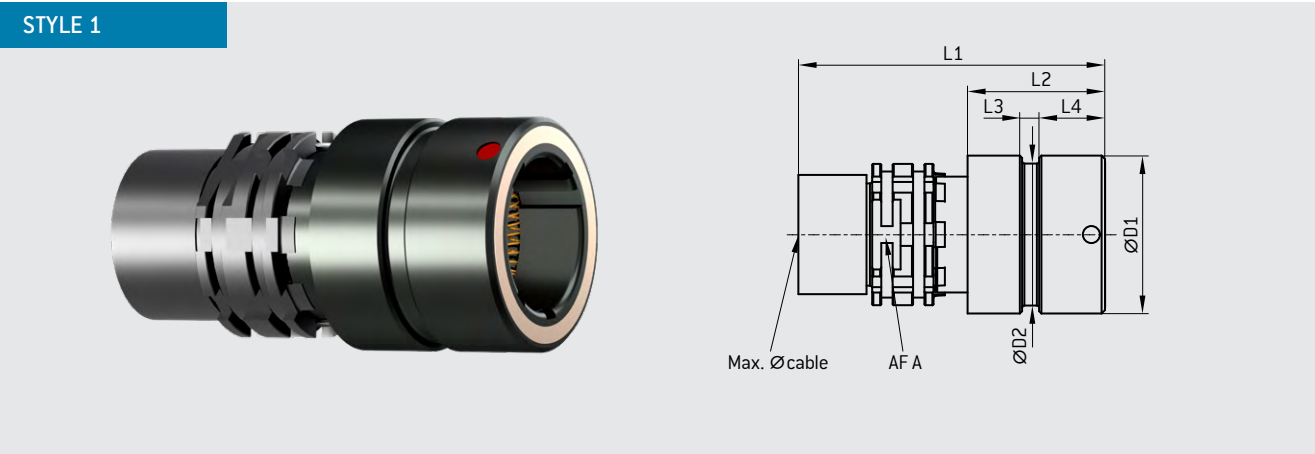

Size		L1 mm	L2 mm	L3 mm	L4 mm	D1 mm	D2 mm	AFA mm	Max Ø-cable ¹ mm
0	0	25.0	13.0	1.5	5.8	11.9	10.5	9	5.5
1	1	27.0	12.1	1.5	5.8	13.9	12.5	11	6.5
1.5	A	27.0	12.0	1.5	5.8	15.9	14.5	12	8.0

TECHNICAL DATA

- Technical data see page 42
- Contact configuration see page 32
- Cable assembly information see ODU instruction 010.645.001.000.003 (available at www.odu-connectors.com/downloads/assembly-instructions/)

¹ Based on cable with one braided shield



1	2	3	4	5	6	7	8	9	10	11	12	13	14	15	16	17	18	19
K	1	Y	R	-	P								0	-	R	0	0	0

RECEPTACLE

STYLE K

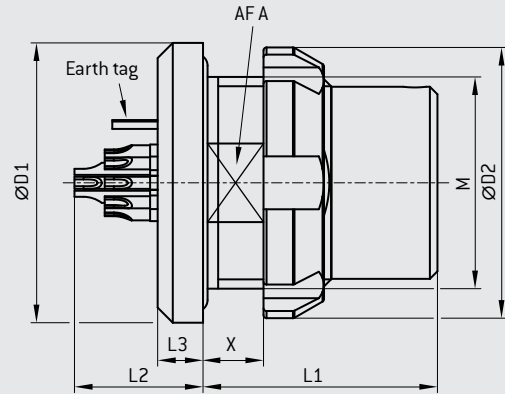

For installation from rear of panel – low profile inside the device

Size		L1 mm	L2 max mm	L3 mm	X max mm	D1 mm	D2 mm	AFA mm	M mm	Panel cut out	
										AF mm	Ø mm
0	0	15.5	7.3	2.5	7.0	15.5	15.0	10	11×0.75	10.1	11.1
1	1	15.5	7.4	3.0	4.0	18.5	17.9	13	14×1	13.1	14.1
1.5	A	16.5	8.2	3.0	5.5	18.9	17.9	13	14×0.75	13.1	14.1

Panel cut out

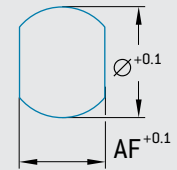

NUTDRIVER FOR SLOTTED NUT

Size	Number	Torque Nm
0	700.098.001.000.000	1.0
1	701.098.002.000.000	3.0
1.5 (A)	701.098.002.000.000	3.0

TECHNICAL DATA

- Technical data see page 42
- Contact configuration see page 32
- IP68, also in unmated condition

1 2 3 4 5 6 7 8 9 10 11 12 13 14 15 16 17 18 19

G | K | Y | R | - | P | | | | | | | | O | - | R | O | O | L

RECEPTACLE

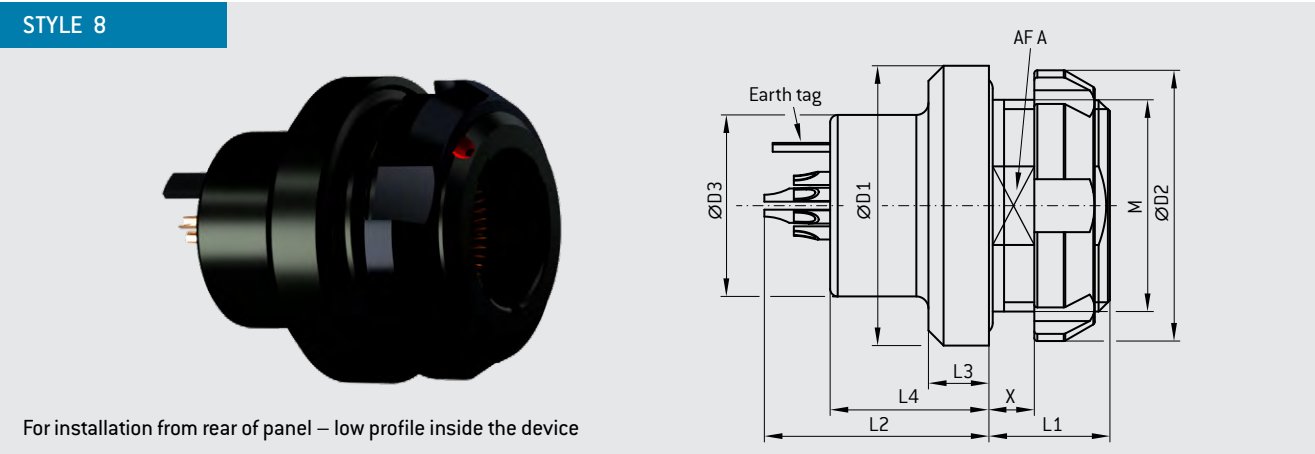

Size		L1 mm	L2 max mm	L3 mm	L4 mm	X max mm	D1 mm	D2 mm	D3 mm	AFA mm	M mm	Panel cut out AF mm	Ø mm
0	0	6.5	16.3	3.0	11.5	3.0	15.5	15.0	10.0	10	11×0.75	10.1	11.1
1	1	8.0	14.9	4.0	10.5	3.5	18.5	17.9	12.0	13	14×1	13.1	14.1
1.5	A	7.0	17.7	2.5	12.5	3.0	18.9	17.9	14.0	13	14×0.75	13.1	14.1

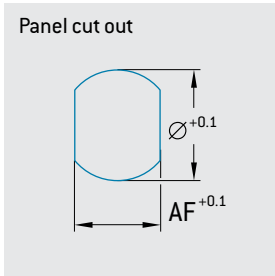

NUTDRIVER FOR SLOTTED NUT

Size	Number	Torque Nm
0	700.098.001.000.000	1.0
1	701.098.002.000.000	3.0
1.5 (A)	701.098.002.000.000	3.0

TECHNICAL DATA









- Technical data see page 42
- Contact configuration and PCB layout see page 32
- IP68, also in unmated condition

1 2 3 4 5 6 7 8 9 10 11 12 13 14 15 16 17 18 19

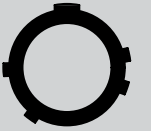
G | 8 | Y | R | - | P | | | | | 0 | - | R | 0 | 0 | L

CODING POSSIBILITIES

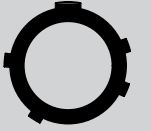
HOUSING MATERIAL

Coding	Plug front view	Colour coding	Colour
A			Light brown
B			Red
C			Blue
D			Green

Coding	Housing material
R	Aluminium EN-6023 Ruthenium over electroless Ni

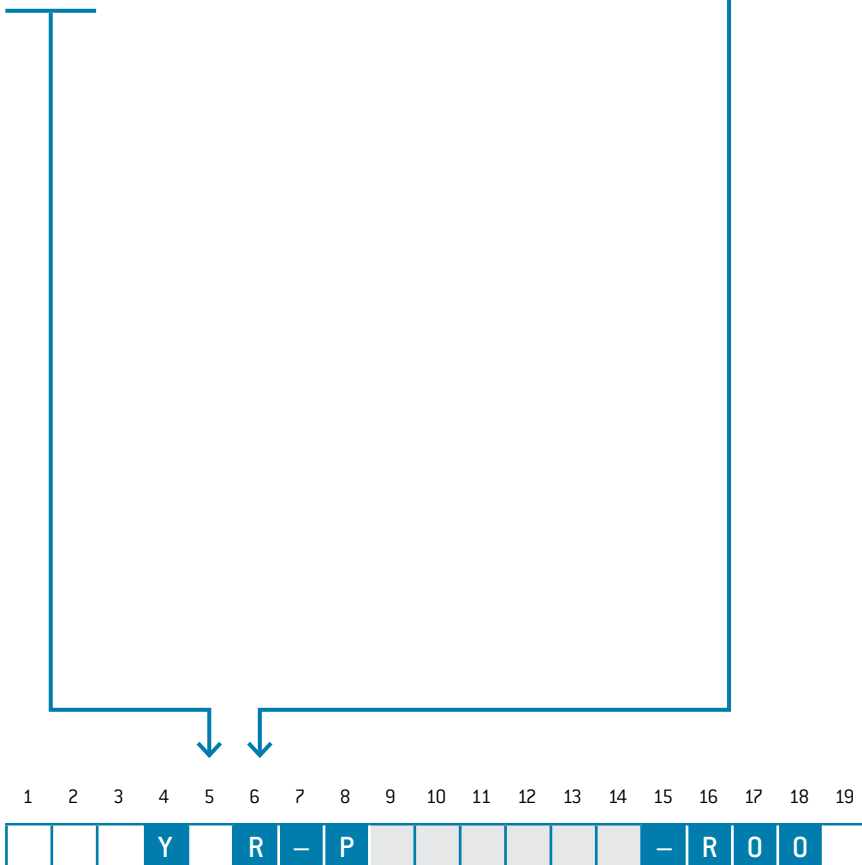

FOR YOUR NOTES

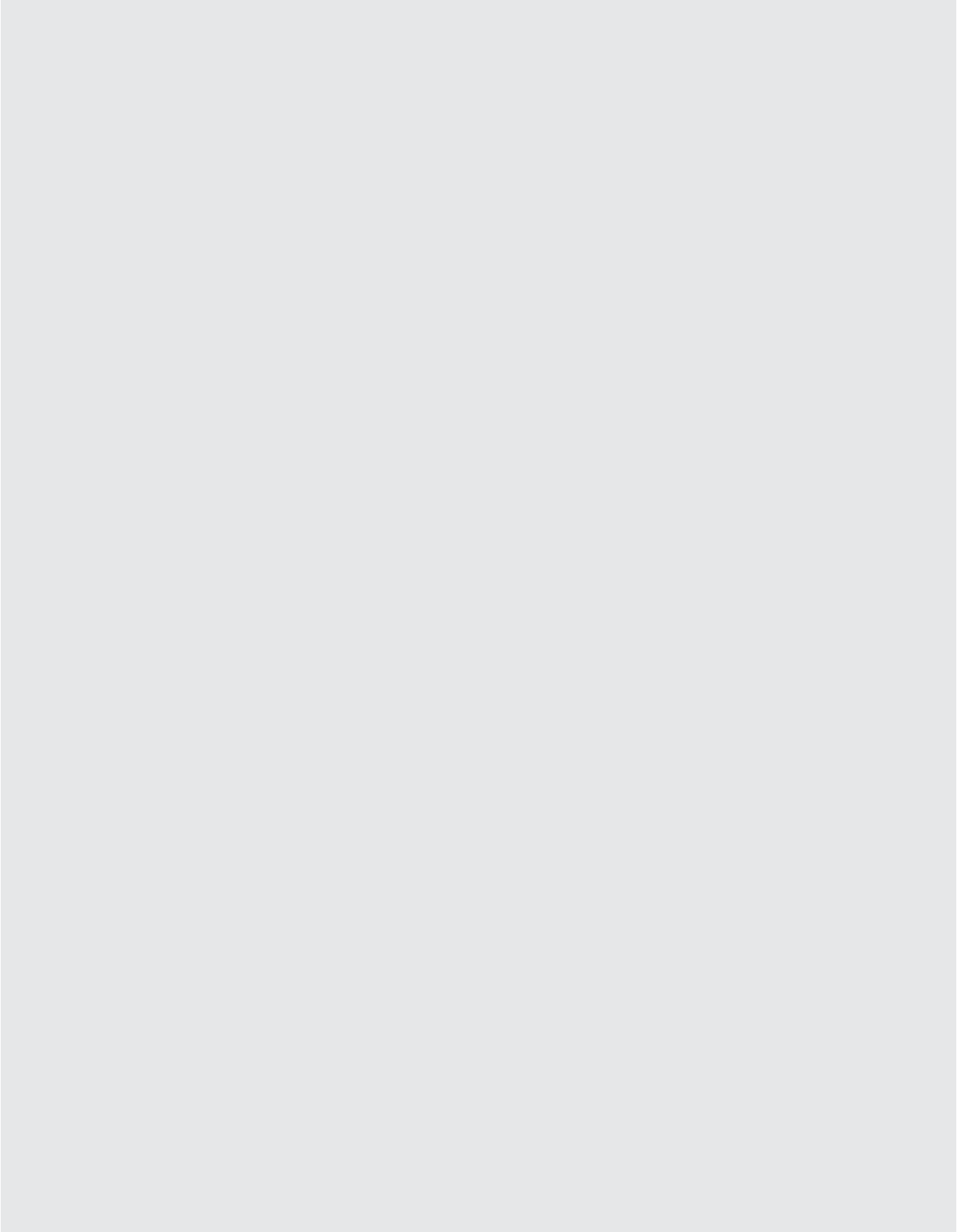

CONTACT CONFIGURATIONS

SIZE 0

Number of contacts ¹		Available connector styles			Contact type		Part number key				Contact diameter mm	Single contact nominal current ² A	Test voltage ³ Contact to contact kVeff	Rated voltage ⁴ kVrms	Termination		
						Termination									mm	AWG	mm ²
0	4	A1	–	–	Flat contact	Solder	W	D	D	0	0.6	2.0	0.600	0.200	0.65	26	0.15
		–	–	–		Print	U	D	0	0					0.5	–	–
		G8	GK	K1	Spring load contact	Solder	X	D	D	0					0.65	26	0.15
				–		Print	V	D	0	0					0.5	–	–
0	7	A1	–	–	Flat contact	Solder	W	D	D	0	0.6	1.3	0.600	0.200	0.65	26	0.15
		–	–	–		Print	U	D	0	0					0.5	–	–
		G8	GK	K1	Spring load contact	Solder	X	D	D	0					0.65	26	0.15
				–		Print	V	D	0	0					0.5	–	–

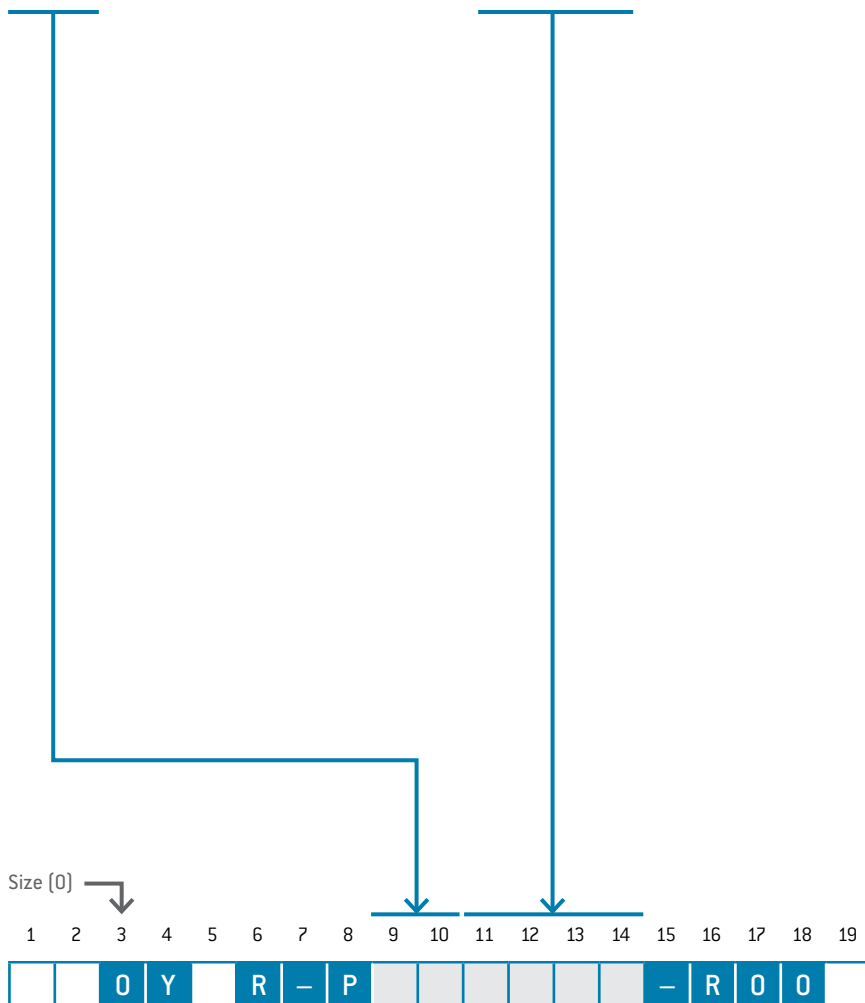

¹ Other contact configurations on request.

² Derating factor see page 48

³ SAE AS 13441:2004 method 3001.1

⁴ Max. operating voltage at NN (sea level) acc. to SAE AS 13441:2004 method 3001.1

Further information on page 49

PCB LAYOUT PRINT CONTACTS SIZE 0

View on termination area		Number of contacts		Length earth tag and pin		
Spring load contact piece	Flat-contact piece			G8 Pin X mm	GK Pin Y mm	GW Pin Z mm
		4 pos.		4.3	4.3	3.0

LENGTH EARTH TAG AND PIN

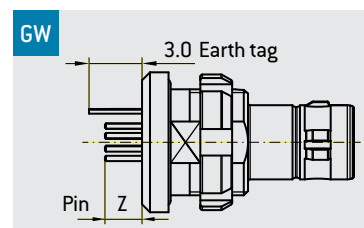
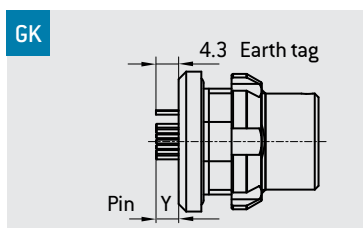
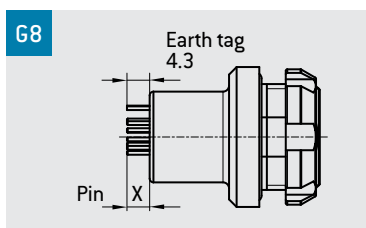

CONTACT CONFIGURATIONS

SIZE 1

Number of contacts ¹		Available connector styles			Contact type		Part number key				Contact diameter mm	Single contact nominal current ² A	Test voltage ³ Contact to contact kVeff	Rated voltage ⁴ kVrms	Termination		
						Termination	W	D	D	0					mm	AWG	mm ²
1	0	A1	GW	-	Flat contact	Solder	W	D	D	0	0.6	1.1	0.600	0.200	0.65	26	0.15
		Print				U	D	0	0	0.5					-	-	
		G8	GK	K1	Spring load contact	Solder	X	D	D	0					0.65	26	0.15
						Print	V	D	0	0					0.5	-	-
1	6	A1	GW	-	Flat contact	Solder	W	D	D	0	0.6	1	0.600	0.200	0.65	26	0.15
		Print				U	D	0	0	0.5					-	-	
		G8	GK	K1	Spring load contact	Solder	X	D	D	0					0.65	26	0.15
						Print	V	D	0	0					0.5	-	-

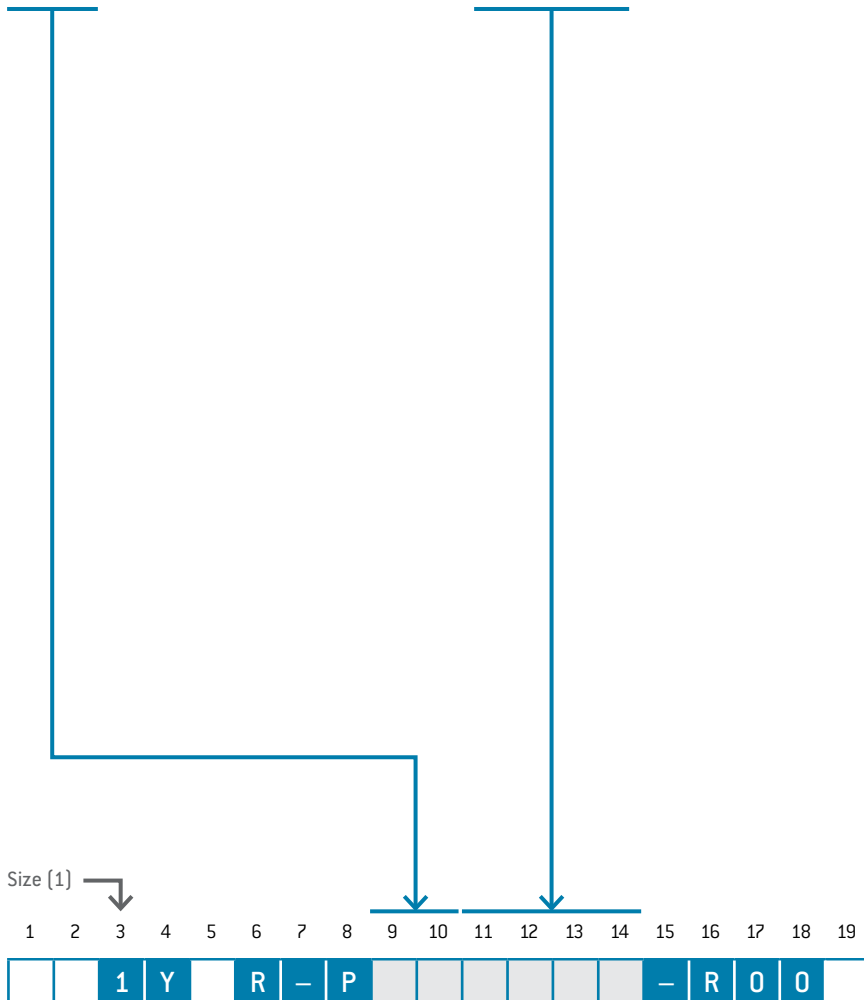

¹ Other contact configurations on request.
² Derating factor see page 48
³ SAE AS 13441:2004 method 3001.1
⁴ Max. operating voltage at NN (sea level) acc. to SAE AS 13441:2004 method 3001.1
 Further information on page 49

PCB LAYOUT PRINT CONTACTS SIZE 1

View on termination area		Number of contacts	Length earth tag and pin												
Spring load contact piece	Flat-contact piece														
			<table border="1"> <thead> <tr> <th>G8</th> <th>GK</th> <th>GW</th> </tr> <tr> <th>Pin X</th> <th>Pin Y</th> <th>Pin Z</th> </tr> <tr> <th>mm</th> <th>mm</th> <th>mm</th> </tr> </thead> <tbody> <tr> <td>3.9</td> <td>3.9</td> <td>3.0</td> </tr> </tbody> </table>	G8	GK	GW	Pin X	Pin Y	Pin Z	mm	mm	mm	3.9	3.9	3.0
G8	GK		GW												
Pin X	Pin Y	Pin Z													
mm	mm	mm													
3.9	3.9	3.0													
			<table border="1"> <thead> <tr> <th>G8</th> <th>GK</th> <th>GW</th> </tr> <tr> <th>Pin X</th> <th>Pin Y</th> <th>Pin Z</th> </tr> <tr> <th>mm</th> <th>mm</th> <th>mm</th> </tr> </thead> <tbody> <tr> <td>3.9</td> <td>3.9</td> <td>3.0</td> </tr> </tbody> </table>	G8	GK	GW	Pin X	Pin Y	Pin Z	mm	mm	mm	3.9	3.9	3.0
G8	GK		GW												
Pin X	Pin Y	Pin Z													
mm	mm	mm													
3.9	3.9	3.0													

LENGTH EARTH TAG AND PIN

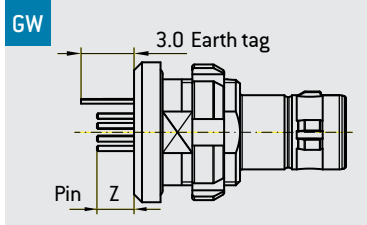
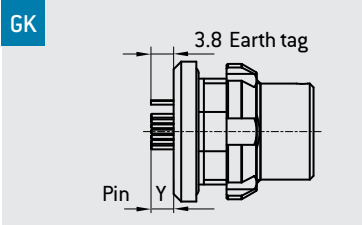
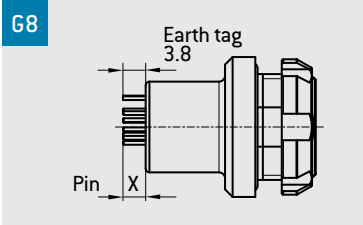

CONTACT CONFIGURATIONS

SIZE 1.5

Number of contacts ¹		Available connector styles			Contact type		Part number key				Contact diameter mm	Single contact nominal current ² A	Test voltage ³ Contact to contact kVeff	Rated voltage ⁴ kVrms	Termination		
						Termination									mm	AWG	mm ²
1	9	A1	GW	-	Flat contact	Solder	W	D	D	0	0.6	0.9	0.600	0.200	0.65	26	0.15
		Print				U	D	0	0	0.5					-	-	
		G8	GK	K1	Spring load contact	Solder	X	D	D	0					0.65	26	0.15
				Print		V	D	0	0	0.5					-	-	

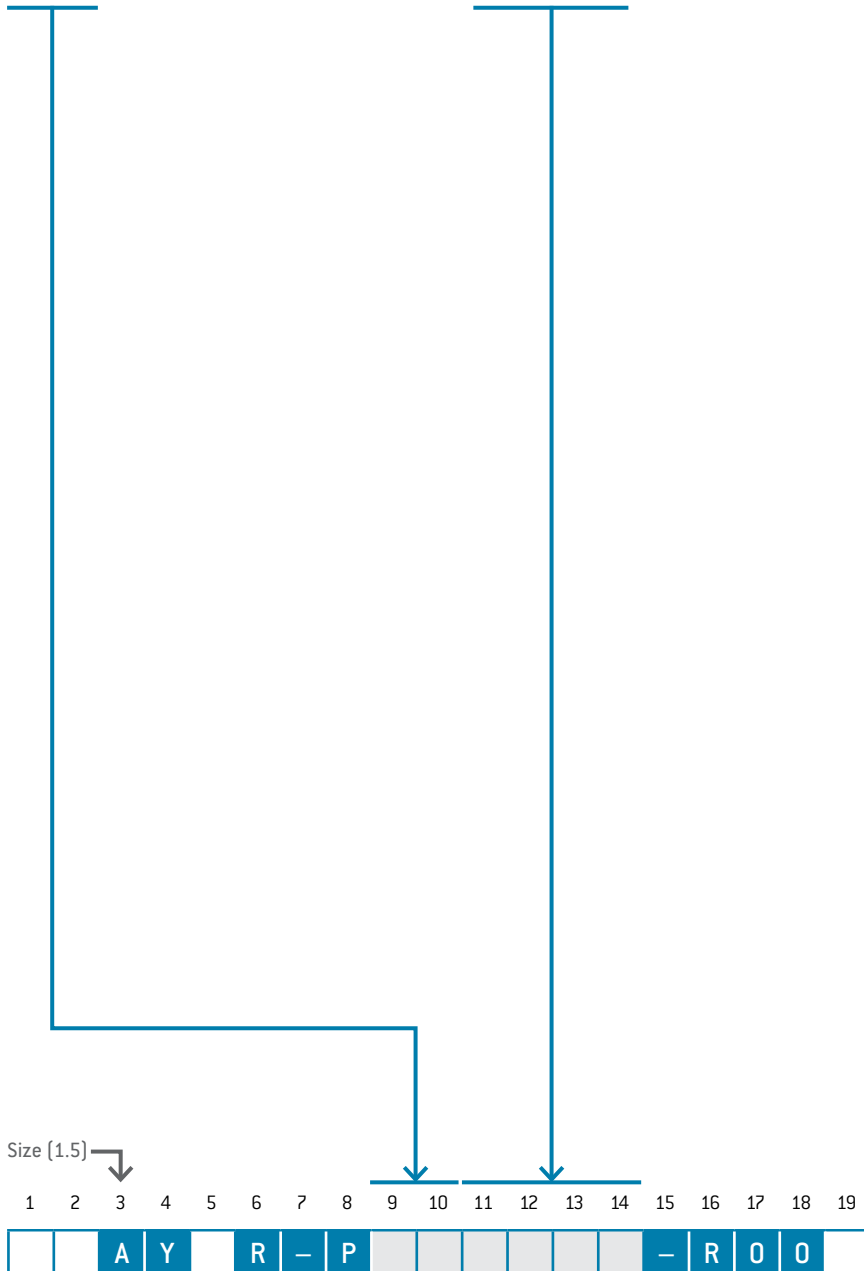

¹ Other contact configurations on request
² Derating factor see page 48
³ SAE AS 13441:2004 method 3001.1
⁴ Max. operating voltage at NN (sea level) acc. to SAE AS 13441:2004 method 3001.1
 Further information on page 49

PCB LAYOUT PRINT CONTACTS SIZE 1.5

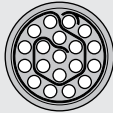
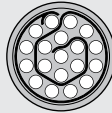
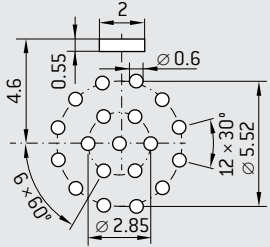
View on termination area		Number of contacts	Length earth tag and pin					
Spring load contact piece	Flat-contact piece		G8 Pin X mm	GK Pin Y mm	GW Pin Z mm			
		19 pos				3.5	3.5	1.5

LENGTH EARTH TAG AND PIN

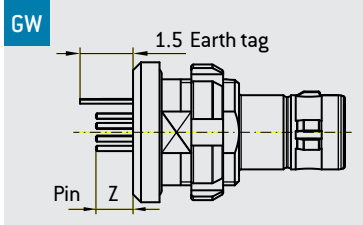
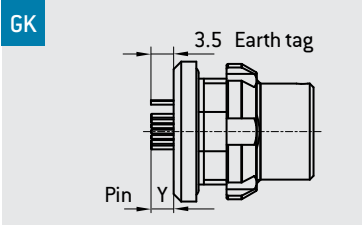
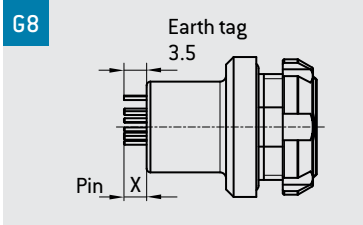

DUST PROTECTION CAPS

ENVIRONMENTAL AND ELECTRICAL CHARACTERISTICS

Type	Performance	Standard
Tightness	IP50	IEC 60529
Operating temperature	-51 °C to +125 °C	IEC 60512-11-9:2002 IEC 60512-11-10:2002
Shielding effectiveness	> 55 dB	VG 95214-11

MATERIAL

Part	Material	Flammability
Cap	Conductive silicone	UL94 (V1)
Lanyard	Aramid	UL94 (V0)
Crimp ferrule, lug	Brass, copper	
Shrinktube	FPO (RNF-100)	ASTM D 876 (30 sec)

Assembly information including tools see ODU instruction 010.645.001.000.005 (available at www.odu-connectors.com/downloads/assembly-instructions)

FOR RECEPTACLES G8 AND GK AND IN-LINE RECEPTACLE K1

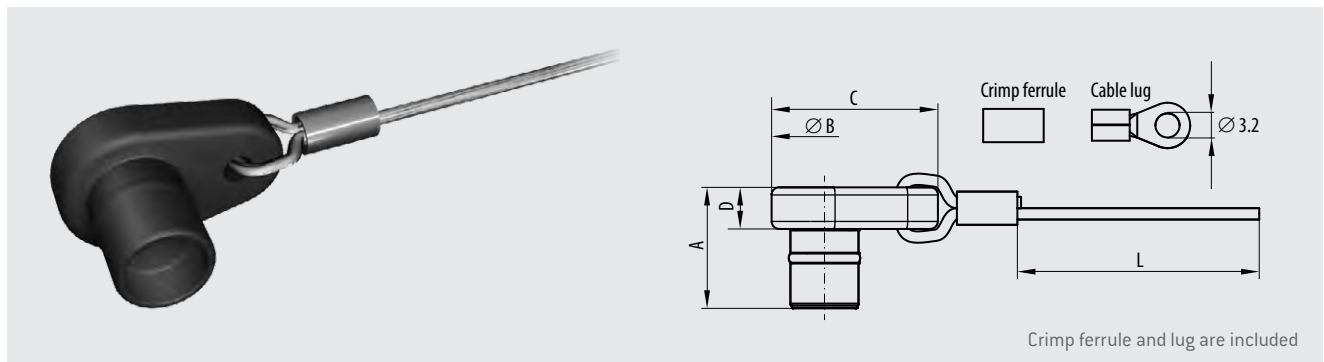

Size	Part number	Dimensions in mm				
		A	B	C	D	L
0	700.645.097.002.945	15.5	12.0	20.0	5.5	200
1	701.645.097.002.945	16.0	14.0	22.0	5.5	200
1.5	715.645.097.002.945	15.3	15.0	23.0	5.5	200

FOR YOUR NOTES

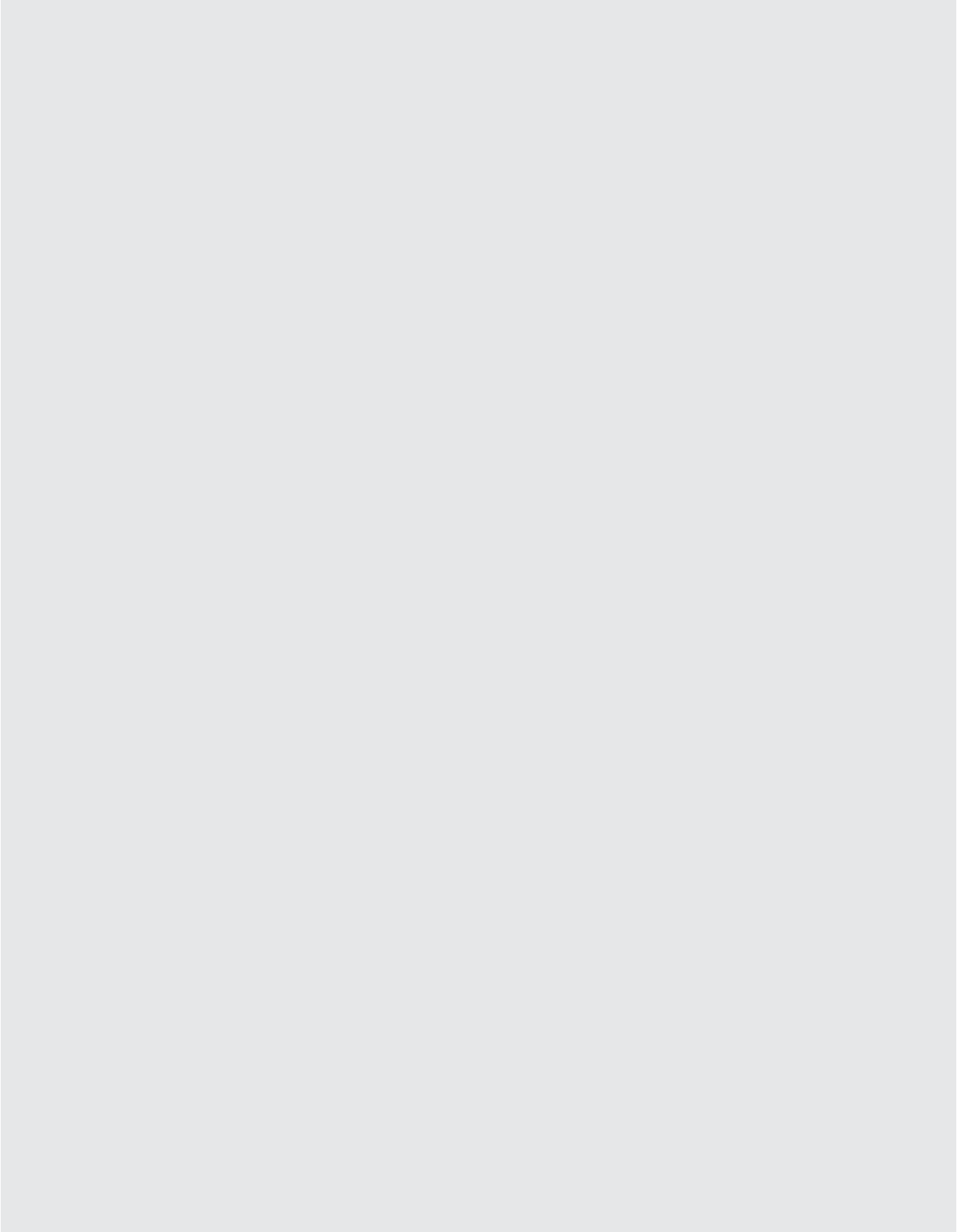

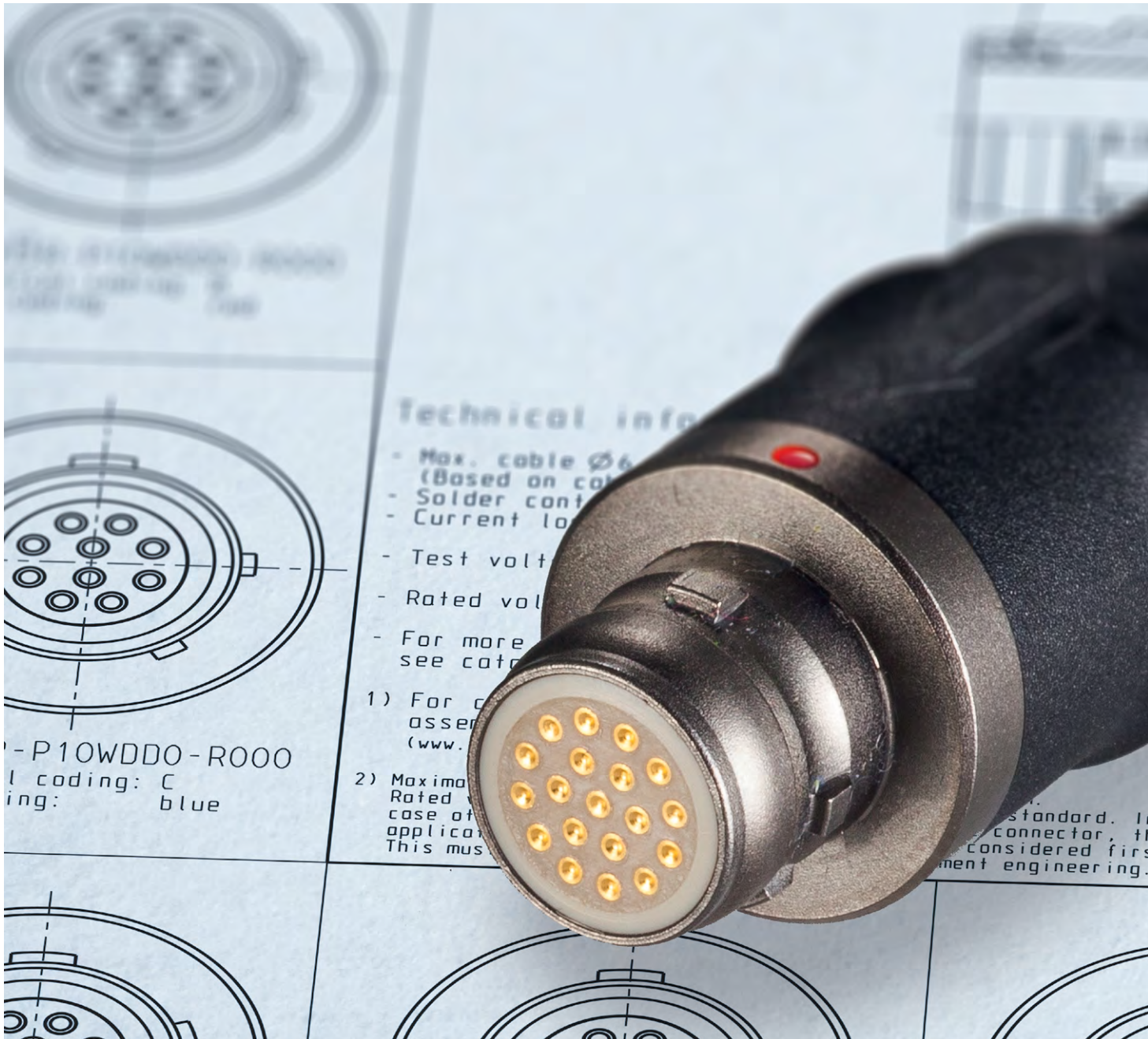

ODU AMC® EASY-CLEAN

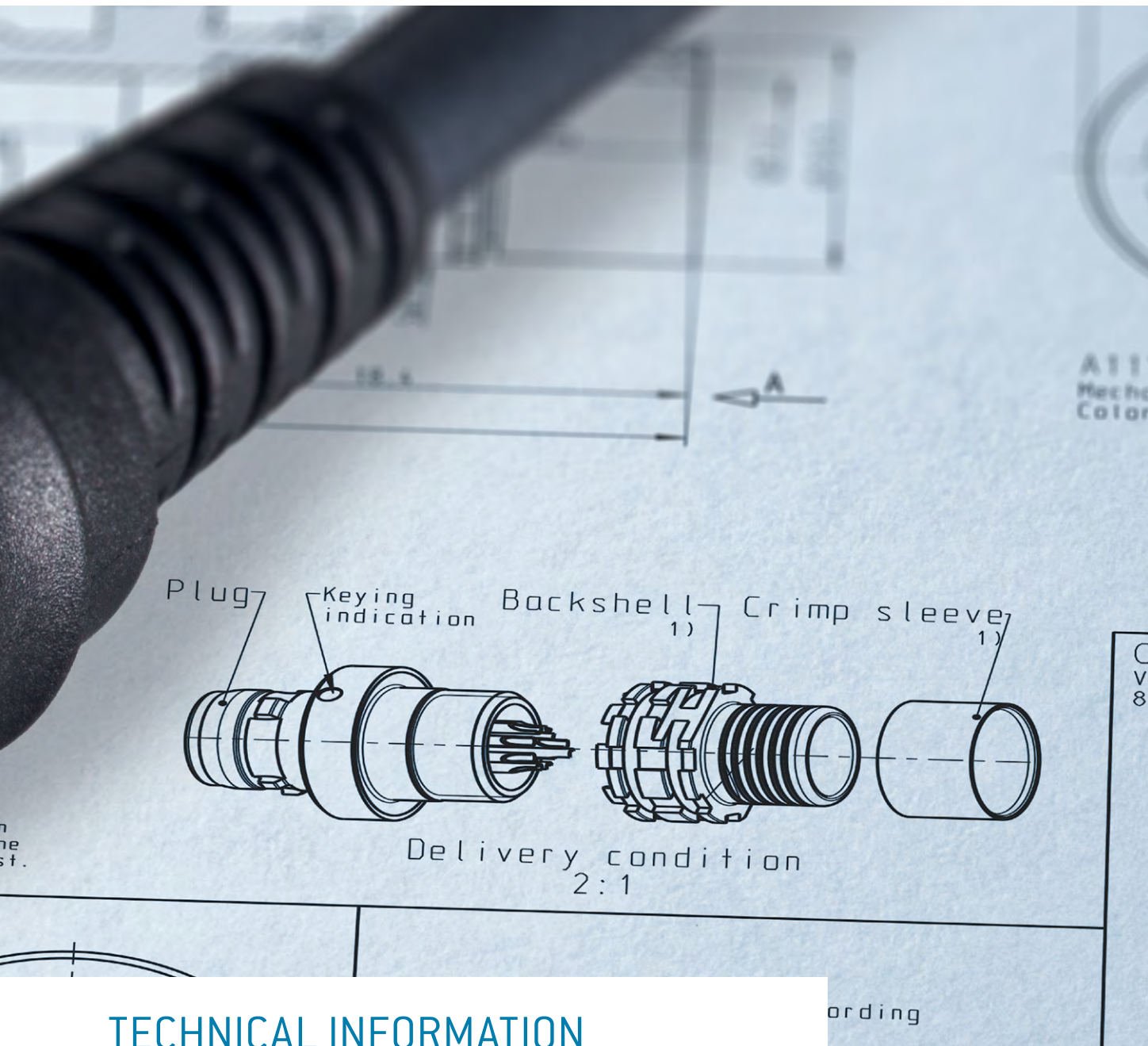

TECHNICAL INFORMATION

Technical data	42
International protection classes	44
Spring loaded contact	45
Watertightness of the ODU AMC® Easy-Clean	46
Current load – contacts	48
Operating voltage	49
Conversion / AWG	50
Technical terms	51

TECHNICAL DATA

ENVIRONMENTAL AND TESTING

Type	Performance	Standard
Tightness	IP68 / 1 m, IP69	IEC 60529 / MIL-STD-810F 512.4/5 DIN 40050-9
Sand and dust	Blowing sand and dust, settling dust	MIL-STD-810F 510.4/5 Procedure I / II DIN 40050-9 / IP6kx
Operating temperature	-51 °C up to +125 °C	IEC 60512-11-9:2002 IEC 60512-11-10:2002
Thermal shock	-65 °C up to +150 °C	EIA 364-32-E, IEC 60068-2-14
Humidity cyclic	85 % up to 95 %, 28 °C up to 71 °C	MIL-STD-1344A Method 1002.2 Type III, IEC 60068-2-38
Low pressure (rapid decompression)	59.1 kPa to 18.8 kPa	AECTP 300, 312 Procedure III (STANAG 4370)
Low pressure	57.2 kPa, -55 °C	MIL-STD-810F 500.4/5 IEC 60068-2-40
Icing	Rime ice 6 mm	MIL-STD-810F 521.2/3
Corrosion resistance	96 h salt mist, 5 % salt solution, 35 °C	EIA-364-26B STANAG 4370, AECTP 300-309 MIL-STD-810F 509.4/5
Mould growth	European fungus	IEC 60068-2-10:2005
Solar radiation		IEC 60068-2-5:2018
Chemical endurance	Several substances	ISO 16750-5:2010-04

¹ Including temperature rise due to contact load

² Substances listed at ODU datasheet 009.410.021.000.000

RoHS 2011/65/EC recognized

MECHANICAL DATA

Type	Performance	Standard
Mechanical endurance	5,000 mating cycles ¹	IEC 60512-5-9-a EIA-364-09
Vibration		MIL-STD 1344 Method 2005 EIA-364-28
Shock	100 g amplitude, half sine pulse of 3 ms, no discontinuity > 1 μs	MIL-STD 1344 Method 2004 EIA-364-27

¹ 5,000 mating cycles, dependent on the specific application

ELECTRICAL DATA

Type	Performance	Standard
Contact resistance (fig. 1) over 5,000 mating cycles	Contact diameter / resistance Ø 0.6 mm pogo pin < 20 mΩhm	IEC 60512-2-1:2002
Shell resistance (fig. 2)	< 10 mΩhm	IEC 60512-2-1:2002
Insulation resistance	> 100 MΩhm	IEC 60512-3-1:2002

MEASUREMENT POINTS

FIG. 1

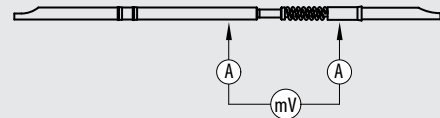
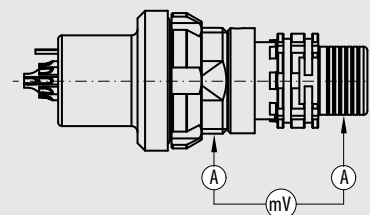

FIG. 2







MATERIAL AND SURFACE TREATMENTS

Type	Material	Standard		Surface	Standard	Flammability
		EU	US			
Housing (conductive parts)	Aluminium AlMgSiSn1Bi	EN-AW 6023		Ruthenium over electroless nickel		
Nut	Aluminium AlMgSiSn1Bi	EN-AW 6023		Black anodized		
Backshell	Aluminium AlMgSiSn1Bi	EN-AW 6023		Electroless nickel	SAE-AMS2404	
EMI-locking ring	Stainless steel	CW102C (2.1248)		Electrodeposited gold		
Crimp sleeve	CuZn38Pb1.5	CW608N (2.0371)	C35300	Electrodeposited nickel		
Colour ring	PSU					UL94 (V0)
Insulator	PEEK					UL94 (V0)
Pin contact (pogo-pin)	Copper alloy, CuBe, steel,			1.25 µm gold over electro-deposited nickel (on piston)	MIL-G-45204D	
Socket contact	Copper alloy	CW614N (2.0401)	C38500	1.25 µm gold over electrodeposited nickel	MIL-G-45204D	
O-rings	FVMQ (floursilikon)					
Potting	Potting compound					UL94 (V0)
Overmolding material	TPU					UL94 (HB)
Shrink boots	Polyester-elastomere					Acc. to VG95343

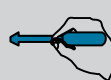

INTERNATIONAL PROTECTION CLASSES

ACC. IEC 60529:1989/A2:2013/COR1:2019 (VDE 0470-1:2014-09)

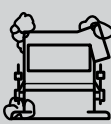
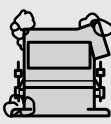
Code letters (International Protection)		First code number (Degrees of protection against access to hazardous parts respectively against solid foreign objects)		Second code number (Degrees of protection against water)		
IP		6		5		
Code number	Protection against access to hazardous parts / Protection against ingress of solid foreign objects			Code number	Protection against harmful effects due to the ingress of water	
0	No protection		No protection against contact / No protection against solid foreign objects	0	No protection against water	No protection against water
1	Protection against large foreign objects		Protection against contact with the back of the hand / Protection against solid foreign objects $\varnothing \geq 50$ mm	1	Protection against dripping water	Protection against vertically falling waterdrops
2	Protection against medium-sized foreign objects		Protection against contact with the fingers / Protection against solid foreign objects $\varnothing \geq 12.5$ mm	2	Protection against dripping water (tilted)	Protection against falling waterdrops when tilted (any angle up to 15° from the vertical)
3	Protection against small foreign objects		Protection against contact with tools / Protection against solid foreign objects $\varnothing \geq 2.5$ mm	3	Protection against spray water	Protection against spray water (any angle up to 60° from the vertical)
4	Protection against granular foreign objects		Protection against contact with a wire / Protection against solid foreign objects $\varnothing \geq 1.0$ mm	4	Protection against splashing water	Protection against splashing water from all directions
5	Dustproof		Protection against contact with a wire / Protection against uncontrolled ingress of dust	5	Protection against water jet	Protection against water jet from all directions
6	Dustproof		Protection against contact with a wire / Complete protection against ingress of dust	6	Protection against powerful water jet	Protection against powerful water jet from all directions
				7	Protection against the effects of temporary immersion in water	Protection against ingress of harmful quantities of water by temporary submersion into water
				8	Protection against the effects of continuous immersion in water	Protection against ingress of harmful quantities of water by continuous submersion into water
				9K	Protection against high pressure water jet featuring high temperatures	Protection against water from all directions by high pressure and high temperatures

SPRING LOADED CONTACT

The contacts within the ODU AMC® Easy-Clean series are patented spring loaded contacts made by a leading swiss manufacturer.

Mating cycles	> 5,000
Material:	
Piston	Gold plated machined brass
Barrel	Tin plated machined brass
Spring	Stainless steel
CIIP	Gold plated BeCu C17200

	Plug	Receptacle
Solder termination	●	●
PCB termination	●	●

Information on diameters, terminal types and current-carrying capacity can be found after the inserts.

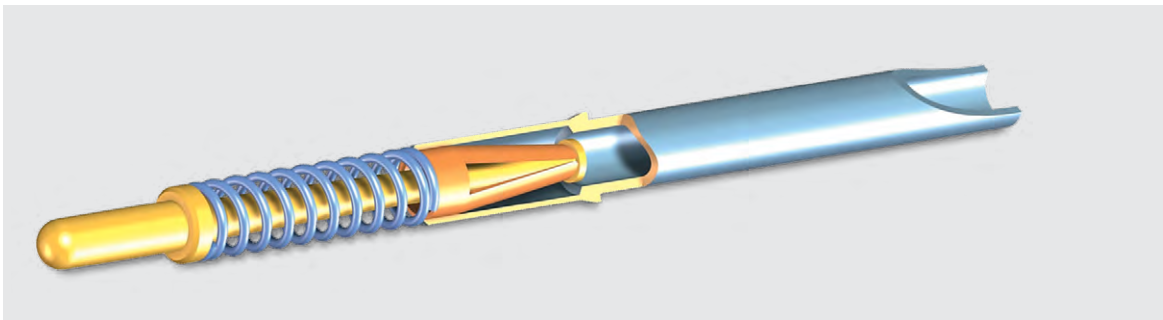

DUST CAPS OF THE ODU AMC® EASY-CLEAN

INSTALLATION SITUATIONS		IP CLASS
MATED WITH CAP		IP50
		IN-LINE RECEPTACLE <input checked="" type="checkbox"/>
		PANEL MOUNT RECEPTACLE (G8, GK) <input checked="" type="checkbox"/>

WATERTIGHTNESS OF THE ODU AMC® EASY-CLEAN

INSTALLATION SITUATIONS		IP CLASS	
		IPX8	IP69
UNMATED		BREAK-AWAY PLUG ² ✓	✗
		PANEL MOUNT PLUG (GW) ² ✓	✗
		IN-LINE RECEPTACLE ² ✓	✗
		PANEL MOUNT RECEPTACLE (GK,G8) ² ✓	✗
		IP68 ¹	IP69
MATED		PLUG WITH PANEL MOUNT RECEPTACLE ✓	✓
		PLUG WITH IN-LINE RECEPTACLE ✓	✓
		PANEL MOUNT PLUG WITH IN-LINE RECEPTACLE ✓	✓

¹ IPX8 1m [MIL 810F 512.4/5], IP69K DIN 40050-9

² Contact area not IP protected

CURRENT LOAD OF SPRING LOADED CONTACT

NOMINAL SINGLE CONTACT CURRENT LOAD FOR SPRING LOAD CONTACT (PISTON DIAMETER 0.6 mm)

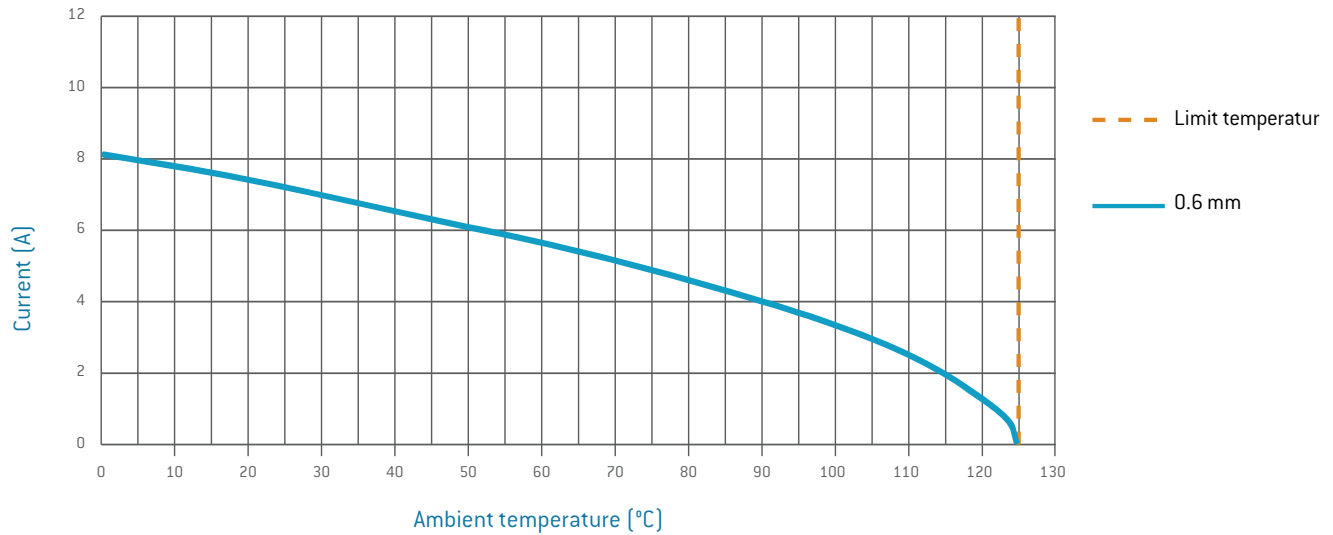

UPPER LIMIT TEMPERATURE OF SPRING LOAD CONTACT: +125 °C

In the case of multi-position connectors and cables, the heating is greater than it is with individual contacts. For that reason, it is calculated with a derating factor.

For connectors, the derating factors for multi-core cables pursuant to VDE 0298-4:2013-06 are applied. The derating factor is factored in at 5 live wires and up.

DERATING CURVE

The corrected current-carrying capacity curve, derived from the base curve determined (0.8 × measured current). It factors in manufacturing tolerances as well as uncertainties in temperature measurement and measurement arrangement. See derating measurement method.

DERATING FACTOR

Number of loaded wires	Derating factor
5	0.75
7	0.65
10	0.55
14	0.50
19	0.45

OPERATING VOLTAGE

ACC. TO SAE AS 13441-METHOD 3001.1

The values acc. to SAE AS 13441:2004-method 3001.1 comply with MIL-Std. 1344 – method 3001.

The inserts have been tested in mated condition and the test voltage was applied to the pin insert.

75 % of the measured break-down voltage is the basic for the further calculation. $\frac{1}{3}$ of this value is the corresponding operating voltage.

All tests were performed at standard environment conditions (room temperature) and can be applied up to an altitude of 2,000 m. For any deviations one has to consider the reduction factor acc. to the relevant standards.

Test voltage: Break-down voltage $\times 0.75$
Operating voltage: Break-down voltage $\times 0.75 \times 0.33$

Suitable safety precautions must be taken in order to ensure that personnel do not come into contact with live conductors during installation and operation.

All entries were reviewed with maximum care before this catalogue was printed.

ODU reserves the right to make changes in accordance with the current state of the art without advance notice, and without being obligated to provide replacement deliveries or to continue production of older designs.

CAUTION

Electrical appliances: for various applications the safety requirements regarding the operating voltage is even more severe!

The relevant datas in such cases for the operating voltage are the creepage and clearance distances. For any advise how to chose the proper connector please consult us and indicate the safty standard which your product has to meet.

CONVERSIONS / AWG (AMERICAN WIRE GAUGE)

Circular wire					
AWG	Diameter		Cross-section mm ²	Weight kg / km	Max. resistance Ω / km
	Inch	mm			
10 (1)	0.1019	2.590	5.26	46.77	3.45
10 (37/26)	0.1150	2.921	4.74	42.10	4.13
12 (1)	0.0808	2.050	3.31	29.41	5.45
12 (19/25)	0.0930	2.362	3.08	27.36	6.14
12 (37/28)	0.0910	2.311	2.97	26.45	6.36
14 (1)	0.0641	1.630	2.08	18.51	8.79
14 (19/27)	0.0730	1.854	1.94	17.23	9.94
14 (37/30)	0.0735	1.867	2.08	18.870	10.50
16 (1)	0.0508	1.290	1.31	11.625	13.94
16 (19/29)	0.0590	1.499	1.23	10.928	15.70
18 (1)	0.0403	1.020	0.823	7.316	22.18
18 (19/30)	0.0052	1.321	0.963	8.564	20.40
20 (1)	0.0320	0.813	0.519	4.613	35.10
20 (7/28)	0.0390	0.991	0.563	5.003	34.10
20 (19/32)	0.0420	1.067	0.616	5.473	32.00
22 (1)	0.0253	0.643	0.324	2.883	57.70
22 (7/30)	0.0288	0.732	0.324	2.965	54.80
22 (19/34)	0.0330	0.838	0.382	3.395	51.80
24 (1)	0.0201	0.511	0.205	1.820	91.20
24 (7/32)	0.0250	0.635	0.227	2.016	86.00
24 (19/36)	0.0270	0.686	0.241	2.145	83.30
26 (1)	0.0159	0.404	0.128	1.139	147.00
26 (7/34)	0.0200	0.508	0.141	1.251	140.00
26 (19/38)	0.0220	0.559	0.154	1.370	131.00
28 (1)	0.0126	0.320	0.0804	0.715	231.00
28 (7/36)	0.0160	0.406	0.0889	0.790	224.00
28 (19/40)	0.0170	0.432	0.0925	0.823	207.00
30 (1)	0.0100	0.254	0.0507	0.450	374.00
30 (7/38)	0.0130	0.330	0.0568	0.505	354.00
30 (19/42)	0.0123	0.312	0.0720	0.622	310.00
32 (1)	0.0080	0.203	0.0324	0.288	561.00
32 (7/40)	0.0110	0.279	0.0341	0.303	597.10
32 (19/44)	0.0100	0.254	0.0440	0.356	492.00
34 (1)	0.0063	0.160	0.0201	0.179	951.00
34 (7/42)	0.0070	0.180	0.0222	0.197	1,491.00
36 (1)	0.0050	0.127	0.0127	0.1126	1,519.00
36 (7/44)	0.0060	0.150	0.0142	0.1263	1,322.00

The American Wire Gauge (AWG) is based on the principle that the cross-section of the wire changes by 26% from one gauge number to the next. The AWG numbers decrease as the wire diameter increases, while the AWG numbers increase as the wire diameter decreases. This only applies to solid wire.

However, stranded wire is predominately used in practice. This has the advantage of a longer service life under bending and vibration as well as greater flexibility in comparison with solid wire.

Stranded wires are made of multiple, smaller-gauge wires (higher AWG number). The stranded wire then receives the AWG numbers of a solid wire with the next closest cross-section to that of the stranded wire. In this case, the cross-section of the stranded wire refers to the sum of the copper cross-sections of the individual wires.

Accordingly, strands with the same AWG number but different numbers of wires differ in cross-section. For instance, an AWG 20 strand of 7 AWG 28 wires has a cross-section of 0.563 mm², while an AWG 20 strand of 19 AWG 32 wires has a cross-section of 0.616 mm².

Source: ASTM

TECHNICAL TERMS

AMBIENT TEMPERATURE

Temperature of the air or other medium in which a piece of equipment is intended to be used in.
(IEC 44/709/CDV:2014 (VDE 0113-1:2019-06))

AWG

American Wire Gauge. See page [50](#).

BASE CURVE

A current-carrying capacity curve metrologically determined according to the method described in IEC 60512-5-2:2002 (DIN EN 60512-5-2:2003-01) depending on the permissible limit temperature of the materials.

CHEMICAL RESISTANCE

Many secondary processing procedures use adhesives, cleaning agents or other chemicals on our products. Contact with unsuitable chemicals may have an adverse effect on the mechanical and electrical properties of the insulation and housing materials which specified properties may not be able to withstand. Please observe our processing suggestions and technical instructions in this catalogue.

CLEARANCE DISTANCE

The shortest distance in the air between two conductive parts.

CODING (ORIENTATION)

Arrangement with which differing polarization of otherwise identical connectors prevents interchangeability. This is a good idea if two or more identical connectors are attached to the same device. See also compatible connectors, see page [30](#).

CONNECTORS

Also known as connectors without contact rating (COC): (IEC 61984:2008 (VDE 0627:2009-11)). An element which enables electrical conductors to be connected and is intended to create and/or separate connections with a suitable counterpart.

CONNECTOR WITHOUT BREAKING CAPACITY (COC)

Connector which is not deemed to be engaged or disengaged in normal use when live or under load.

CONTACT RESISTANCE

Total resistance value measured from terminal to terminal. In this case, the resistance is significantly lower than the contact resistance. The specifications are average values.

CORES

Electrical conductor, solid wire or multi-wire strand, with insulation as well as any conductive layers. Cables or leads may have one or more cores.

CREEPAGE DISTANCES

The shortest distance between two conductive parts along the surface of a solid insulation material. This factors in all elevations and recesses in the insulator, as long as defined minimum dimensions are on hand.

CRIMP BARREL

A terminal sleeve which can accommodate one or more conductor and be crimped by a crimping tool.

CRIMP CONNECTION (CRIMP TERMINATION)

The permanent, non-detachable and solder-free mounting of a contact to a conductor via deforming or shaping under pressure to make a good electrical and mechanical connection. Executed with crimping tool, press or automatic crimping machine.

CRIMPING AREA

The specified area of the crimp barrel in which the crimp termination is executed by means of deforming or shaping the barrel under pressure around the conductor.

DEGREE OF POLLUTION

The effect of pollution is factored in as degree of pollution when measuring clearance and creepage distances.
Four degrees of pollution are defined for the micro-environment: IEC 60664-1:2007 (VDE 0110-1:2008-01).

DELIVERY FORM

Connectors can be delivered in assembled form or as individual parts.

TECHNICAL TERMS

DERATING CURVE

See page [48](#).

DERATING FACTOR

According to VDE 0298-4:2013-06, with connectors and cables over 5 contacts, the heating is greater than it is with individual contacts. For that reason, the aforementioned standard is calculated with a derating factor.

DERATING MEASUREMENT METHOD IEC 60512-5-2:2002 (DIN EN 60512-5-2:2003-01)

Measurement method to determine the current-carrying capacity of connectors in consideration of the maximum permissible limit temperature. See page [48](#).

FIXED CONNECTORS

Intended for mounting on a fixed surface such as a frame, dock, device or wall (with ODU also receptacle or panel mounted plug).

FREE CONNECTORS

Intended for mounting on free ends of mobile leads and cables (with ODU also connectors, plugs, in-line receptacles).

INSULATOR

Part of a connector which separates conductive parts with different potentials from one another; usually identical to the contact carrier.

LOWERMOST LIMIT TEMPERATURE

The lowest permissible temperature at which a connector may be operated.

MATERIALS (STANDARD MODEL)

See page [43](#).

MATING AND DEMATING FORCE

The force required to fully mate or demate pluggable elements without the influence of a coupling or locking device.

MATING CYCLES

Mechanical actuation of connectors via push and pull action. A mating cycle consists of one mating and demating action. ODU's standard value for the ODU AMC® series is 5,000 mating cycles.

MAX. CONTINUOUS CURRENT

The metrologically determined amperage at room temperature (approx. 20° C) which increases the contact temperature to the limit temperature. The values specified in the catalog apply to either individual contacts or completely assembled inserts / modules, as indicated.

NOMINAL SINGLE CONTACT CURRENT LOAD

The current-carrying capacity which each individual contact can be loaded with on its own. See page [48](#).

NOMINAL VOLTAGE

The voltage which the manufacturer specifies for a connector and which the operating and performance features relate to.

OPERATING TEMPERATURE FOR ODU AMC® EASY-CLEAN

Range between the uppermost and lowermost temperature limits; -51° C to +125° C. See page [42](#).

PCB (A.K.A. "PRINTED CIRCUIT BOARD")

A PCB is a carrier for electronic components. It serves the purposes of mechanical mounting and electrical connection.

PCB TERMINATION

Production of a conductive connection between the PCB and an element in through-hole assembly, THT (through-hole technology).

RATED CURRENT (NOMINAL CURRENT)

See page [48](#).

TECHNICAL TERMS

RATED VOLTAGE

According to DIN EN 60644-1:2019-01 standard “Value of a voltage which is specified by the manufacturer for a component, device or operating medium and relates to the operating and performance features.”

SOLDER CONNECTION (SOLDER TERMINATION)

Termination technology in which a molten additional metal (solder) with a lower melting point than the base materials to be connected is used to attach two metallic materials to one another.

TIGHTNESS IEC 60529:2013 (VDE 0470-1:2014-09)

See protection classes on page [44](#).

TERMINATION CROSS-SECTION

The specified cross-sections correspond to a “fine-wire” conductor structure pursuant to DIN EN 60228:2005-09 (VDE 0295:2005-09; class 5) or a “fine-wire” conductor structure (7/19 wire) according to AWG (ASTM B258:2014).

TERMINATION TECHNOLOGIES

Methods for connecting the leads to the electro-mechanical element, such as solder-free connections pursuant to IEC 60352 (DIN EN 60352): crimp, screw connection etc. or soldering connection. See page [45](#).

TEST VOLTAGE

The voltage which a conductor can withstand under defined conditions without dielectric breakdown or flashover.

UPPERMOST LIMIT TEMPERATURE

The maximum permissible temperature at which a connector may be operated. It includes contact heating through current-carrying capacity.

WIRE

Wires (solid conductors) are available with an insulator sleeve and/or electrical shielding. Cables or conductors may be made up of one or more wires.

GENERAL NOTE

The connectors listed in this catalogue are intended for use in high voltage and frequency ranges. Suitable precautionary measures must be taken to ensure that people do not come into contact with live conductors during installation and operation. All entries in this catalogue were thoroughly reviewed before printing. ODU reserves the right to make changes based on the current state of knowledge without prior notice without being obliged to provide replacement deliveries or refinements of older designs.

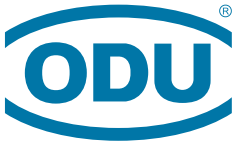

A PERFECT ALLIANCE.

ODU GROUP WORLDWIDE

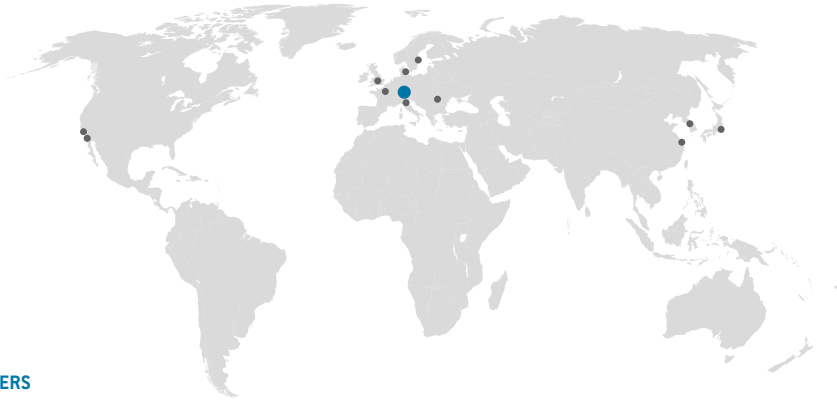

HEADQUARTERS

ODU GmbH & Co. KG

Pregelstraße 11, 84453 Mühldorf a. Inn, Germany
Phone: +49 8631 6156-0, Fax: +49 8631 6156-49, E-mail: sales@odu.de

SALES LOCATIONS

ODU (Shanghai)

International Trading Co., Ltd.
Phone: +86 21 58347828-0
E-mail: sales@odu.com.cn
www.odu.com.cn

ODU Japan K.K.

Phone: +81 3 6441 3210
E-mail: sales@odu.co.jp
www.odu.co.jp

ODU-UK Ltd.

Phone: +44 330 002 0640
E-mail: sales@odu-uk.co.uk
www.odu-uk.co.uk

ODU Denmark ApS

Phone: +45 2233 5335
E-mail: sales@odu-denmark.dk
www.odu-denmark.dk

ODU Korea Inc.

Phone: +82 2 6964 7181
E-mail: sales@odu-korea.kr
www.odu-korea.kr

ODU-USA, Inc.

Phone: +1 805 484-0540
E-mail: sales@odu-usa.com
www.odu-usa.com

ODU France SARL

Phone: +33 1 3935-4690
E-mail: sales@odu.fr
www.odu.fr

ODU Romania Manufacturing S.R.L.

Phone: +40 269 704638
E-mail: sales@odu-romania.ro
www.odu-romania.ro

Further information and specialized representatives can be found at:

www.odu-connectors.com/contact

ODU Italia S.R.L.

Phone: +39 331 8708847
E-mail: sales@odu-italia.it
www.odu-italia.it

ODU Scandinavia AB

Phone: +46 176 18262
E-mail: sales@odu.se
www.odu.se

PRODUCTION AND LOGISTICS SITES

Germany	Otto Dunkel GmbH
China	ODU (Shanghai) Connectors Manufacturing Co.Ltd
Mexico	ODU Mexico Manufacturing S.R.L. de C.V.
Romania	ODU Romania Manufacturing S.R.L.
USA	ODU North American Logistics



Simply scan the QR code
to download the entire publication.

All dimensions are in mm. Some figures are for illustrative purposes only. Subject to change without notice. Errors and omissions excepted. We reserve the right to change our products and their technical specifications at any time in the interest of technical improvement. This publication supersedes all prior publications. This publication is also available as a PDF file that can be downloaded from www.odu-connectors.com

KDMMA Werbeagentur GmbH

ODU / C / 0919 / EN