

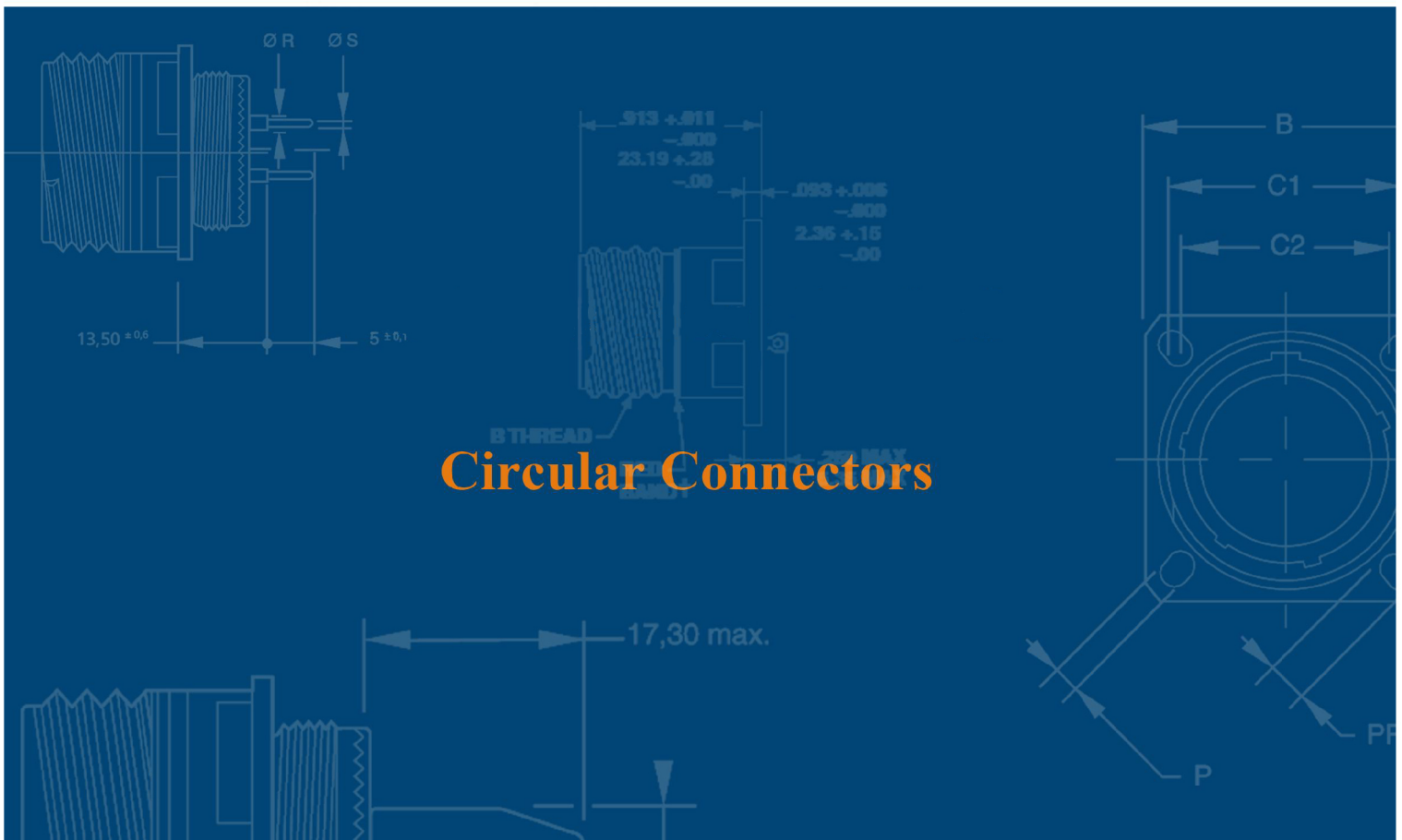

e-mail: sales@fivel.ru

MIL-DTL-38999 Series III

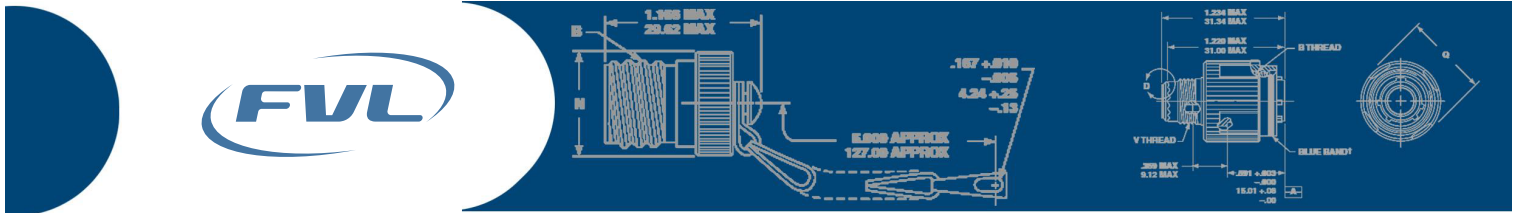



How To Order

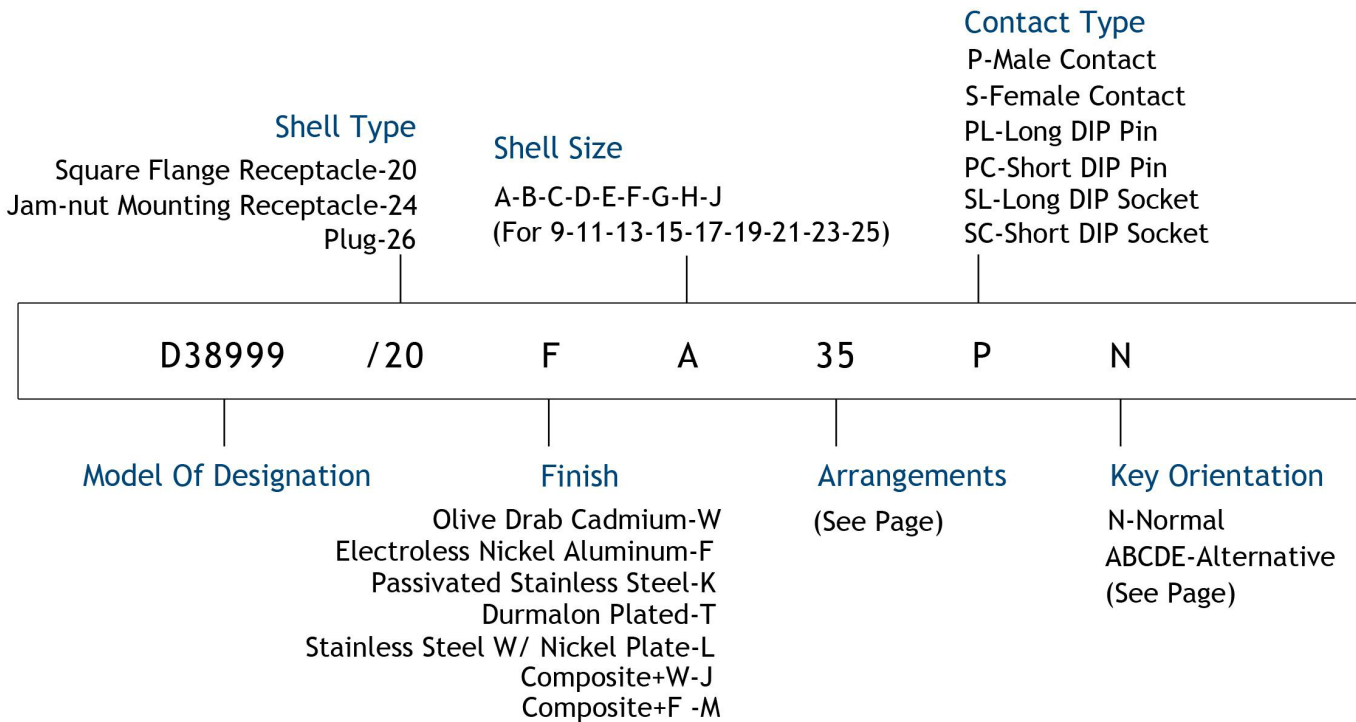

Plug

Sealed receptacles

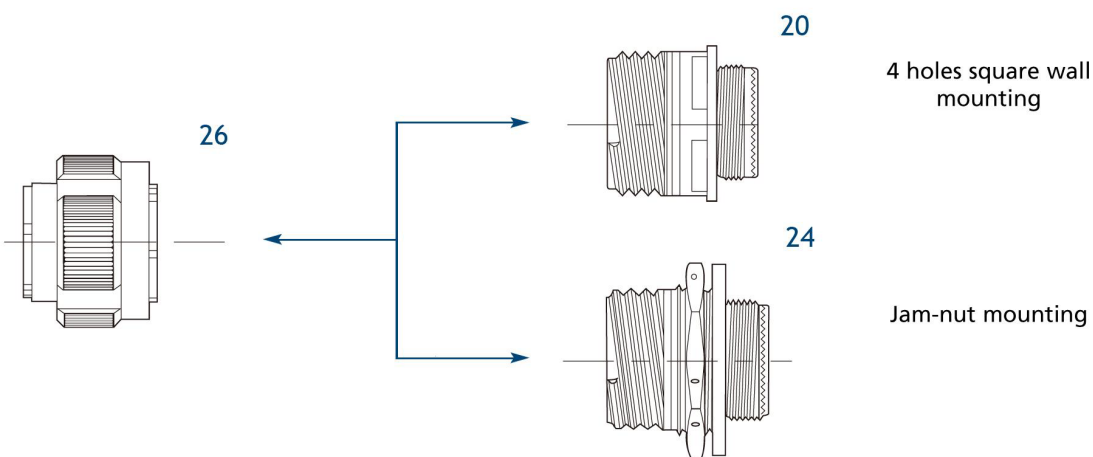

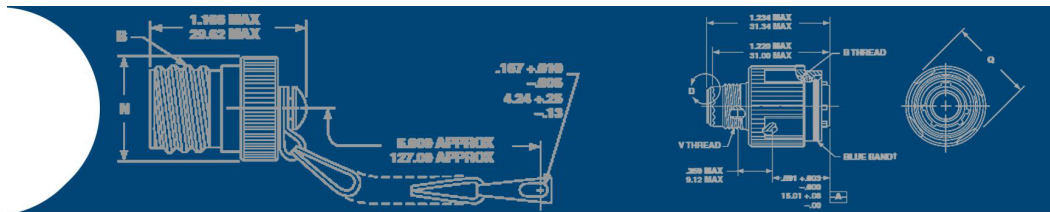

Technical Characteristics

Mechanical

Shell	Material	Sealed version	: Aluminium alloy, Composite
	Plating	Hermetic version	: Stainless steel
RFI ring	Material		: Beryllium copper
	Plating		: Nickel/cadmium
Insert	Material	Sealed version	: Thermoplastic and fluorinated silicone elastomer
		Hermetic version	: Sintered glass insert
Flat gasket and 'o'ring	Material		: Fluoronited silicone elastomer
Contacts	Material	Sealed version	: Copper alloy
	Plating	Hermetic version	: Ferrous alloy
Retention	Type	Sealed version	: Crimp type or pcb (consult us)
		Hermetic version	: Solder type or pcb (consult us)
		Size 22 D	: 4,5 N
		Size 12	: 11,1 N
		Size 20	: 6,7 N
		Size 8	: 11,1 N
		Size 16	: 11,1 N
Vibrations			: As per MIL-DTL-38999
Physical shocks			: 300 g, 3 ms in the 3 axes
Durability			: 500 coupling and uncoupling cycles

Environmental conditions

Service temperature	Sealed version	: Cadmium plating - 65° C to + 175° C
		: Nickel plating - 65° C to + 200° C
	Hermetic version	: Passived plating - 65° C to + 200° C
Thermal shocks		: As per MIL-DTL-38999
Sealing		: Leakage ≤ 16 cm ³ /h on mated connecting under 2.1 bars
Air leakage	Hermetic version	: ≤ 1.10·10 ⁻⁶ mbar. l/s under 1 bar vacuum
Salt spray resistance	Sealed version	: 500 hours class W and K, as per MIL-DTL-38999
		: 48 hours class F and L, as per MIL-DTL-38999

Electrical

Withstanding voltage	At sea level	: Service M : 1300 V	
		: Service I : 1800 V	
	At 70 000 ft altitude	: Service II : 2300 V	Service N : 1000 V
		: Mated connector	Unmated connector
Insulation resistance		: Service M : 800 V	Service M : 200 V
		: Service I : 1000 V	Service I : 200 V
Voltage drop		: Service II : 1000 V	Service II : 200 V
			: ≥ 5000 MΩ to 25° C and 65 % HR max.
Shielding		: Size 22 : test to 5 Amp. = 73 millivolts max.	
		: Size 20 : test to 7,5 Amp. = 55 millivolts max.	
		: Size 16 : test to 13 Amp. = 49 millivolts max.	
		: Size 12 : test to 23 Amp. = 42 millivolts max.	
		: Size 8 : test to 46 Amp. = 26 millivolts max.	
		: As per MIL-DTL-38999	

Size	Contacts current		Diameter over insulation sheath in mm	Permitted wire Section in mm ²
	Sealed version	Hermetic version		
22	5 A	3 A	0,76 to 1,37	0,095 to 0,38
20	7,5 A	5 A	1,01 to 2,10	0,21 to 0,60
16	13 A	10 A	1,65 to 2,77	0,60 to 1,34
12	23 A	17 A	2,46 to 3,61	1,91 to 3,18
8	46 A	40 A	4,50 to 5,80	5,30 to 8,98

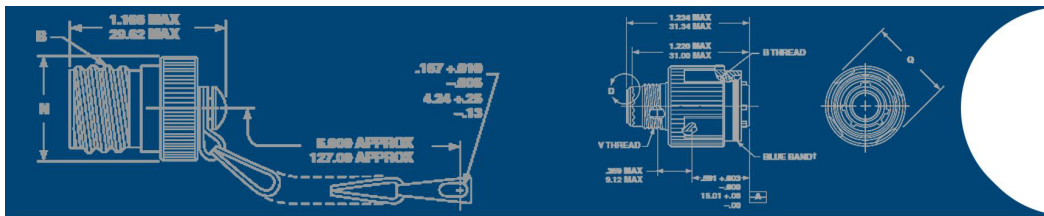

Jam-nut Mounting Receptacle (D38999/24)

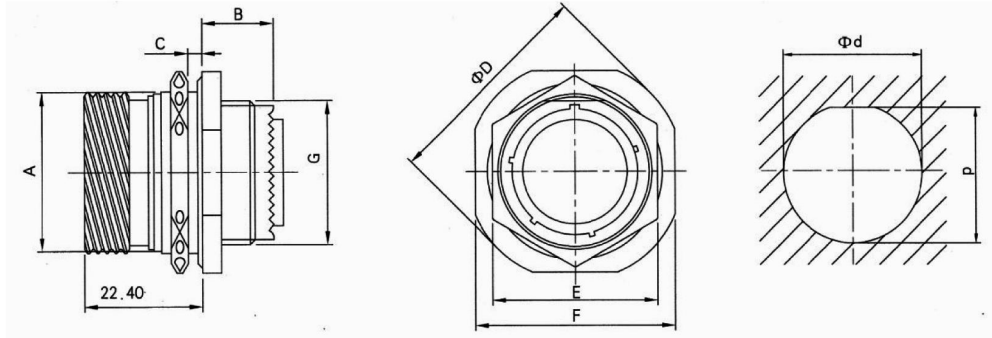

Shell Size	A	B (max)	C (max)	D (max)	E (max)	F	G Thread	d	p
09	16.50	9.90	3.20	30.50	24.00	27.00	M12*1-6g	17.70	16.99
11	19.30	9.90	3.20	35.20	27.00	31.80	M15*1-6g	20.88	19.53
13	24.00	9.90	3.20	38.40	32.00	34.90	M18*1-6g	25.58	24.26
15	27.20	9.90	3.20	41.60	36.00	38.10	M22*1-6g	28.80	27.53
17	30.40	9.90	3.20	44.80	37.00	41.30	M25*1-6g	31.98	30.68
19	33.40	9.90	3.20	49.30	41.00	46.00	M28*1-6g	35.15	33.86
21	36.50	9.90	3.20	52.70	46.00	49.20	M31*1-6g	38.28	37.06
23	39.70	9.90	3.20	55.90	50.00	52.40	M34*1-6g	41.50	40.24
25	42.80	9.90	3.20	59.00	51.23	55.60	M37*1-6g	44.68	43.41

Receptacle, Thru-hole Type

Jam-nut Mounting Receptacle
(D38999/24)

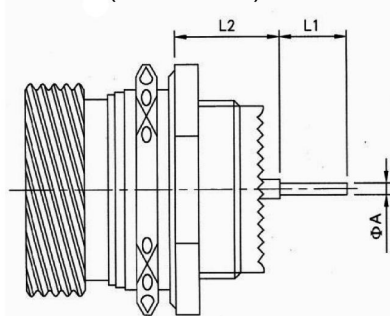

Square Flange Receptacle
(D38999/20)

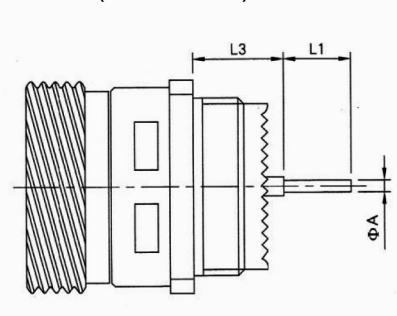

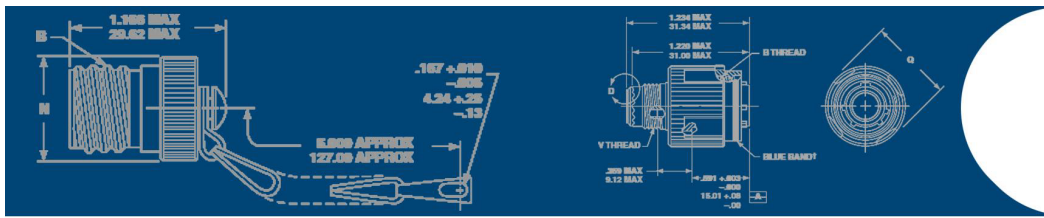

Thru-hole Contacts		L1	A
22D [#]	Long Thru-hole Contacts	8.5	0.7
	Short Thru-hole Contacts	4.0	
20 [#]	Long Thru-hole Contacts	8.5	0.7
	Short Thru-hole Contacts	5.1	
16 [#]	Long Thru-hole Contacts	8.5	1.15
	Short Thru-hole Contacts	5.1	

Dimension with Different Contacts			Shell Size	Shell Size
			09, 11	13, 15, 17, 19, 21, 23, 25
L2	22D [#] Pin	min	10.52	10.34
		max	11.46	11.28
	22D [#] Socket	min	10.19	10.01
		max	11.46	11.28
	16 [#] / 20 [#] Pin, Socket	min	10.69	10.51
		max	11.63	11.45
L3	22D [#] Pin	min	9.48	9.48
		max	10.58	10.58
	22D [#] Socket	min	9.15	9.15
		max	10.58	10.58
	16 [#] / 20 [#] Pin, Socket	min	9.65	9.65
		max	10.75	10.75

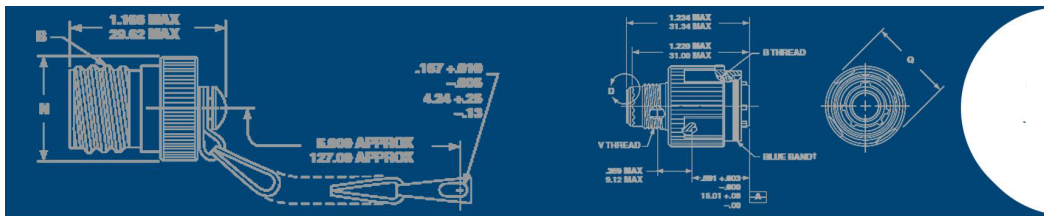

Insert Availability

Shell Size- Inser Arrg	Military Shell Size Code	Service Rating	Total Contacts	Contact Size					
				22D	20	16	12	10	8
19-18		M	18	14					4
19-05			5		1			4	
19-93		I	32	24	6			2	
21-35	G-35	M	79	79					
21-41	G-41	I	41		41				
21-16	G-16	II	16			16			
21-39	G-39	I	39		37	2			
21-11	G-11	II	11				11		
21-27		I	27		27				
21-25		I	25		25				
21-24		I	24		24				
23-35	H-35	M	100	100					
23-55	H-55	I	55		55				
23-53	H-53	I	53		53				
23-36		I	36		36				
23-34		I	34		34				
23-32		I	32		32				
23-21	H-21	II	21			21			
23-97		I	16			16			
23-99		II	11			11			
25-35	J-35	M	128	128					
25-02		I	100	100					
25-61	J-61	I	61		61				
25-29		I	29		29				
25-24	J-24	I	24			12	12		
25-43	J-43	I	43		23	20			
25-19	J-19	I	19				19		
25-04	J-4	I	56		48	8			
25-11			11		2			9	
25-93		M	118	109		8		1	

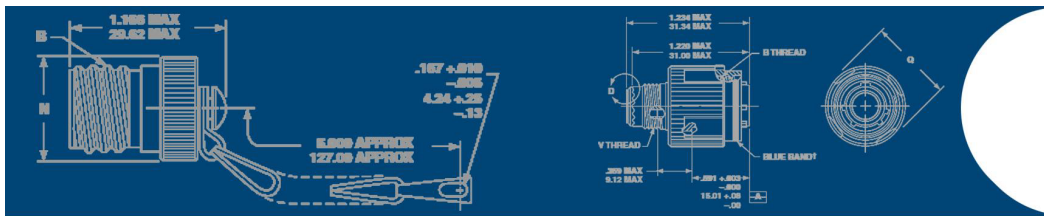

Contact Arrangement



09-35 M



09-98 I

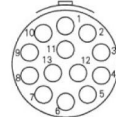

11-35 M

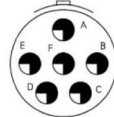

11-98 I

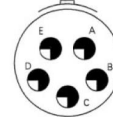

11-05 I

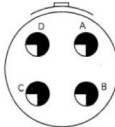

11-04 I

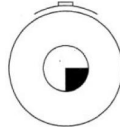

11-01 I

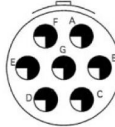

11-99 I

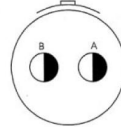

11-02 I

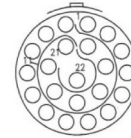

13-35 M

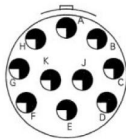

13-98 I

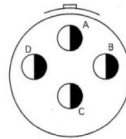

13-04 I

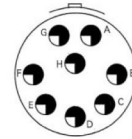

13-08 I

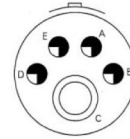

13-50 M

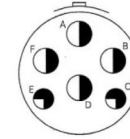

13-60 I

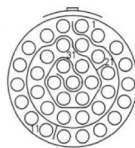

15-35 M

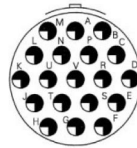

15-19 I

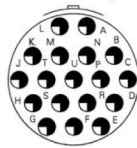

15-18 I

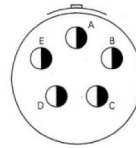

15-05 II

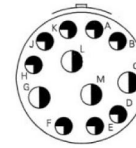

15-97 I

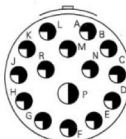

15-15 I

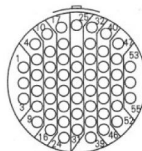

17-35 M

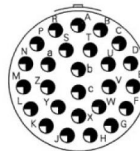

17-26 I

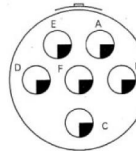

17-06 I

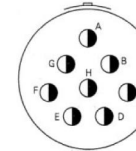

17-08 II

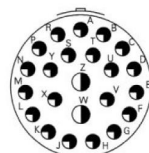

17-99 I

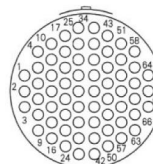

19-35 M

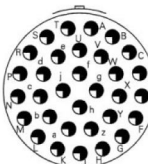

19-32 I

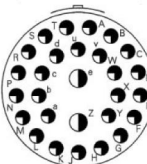

19-28 I

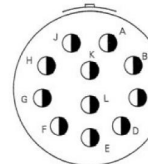

19-11 II

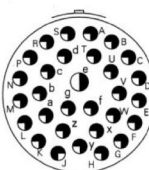

19-30 I

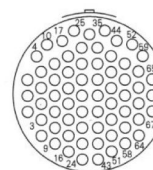

19-45 M

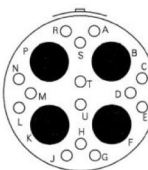

19-18 M

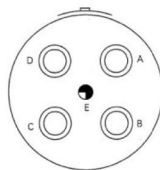

19-05

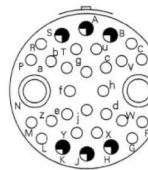

19-93 I

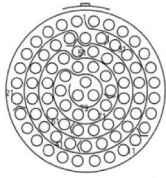
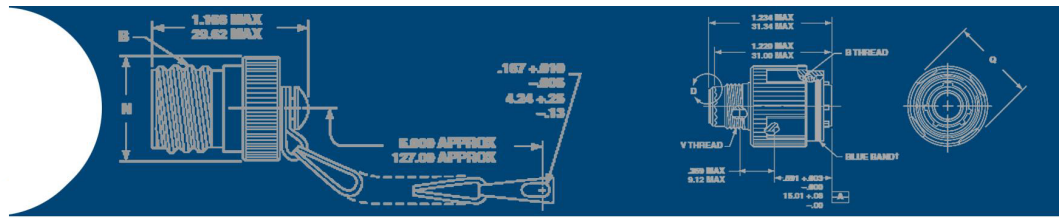

21-35 M

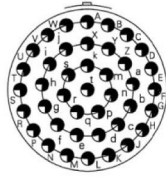

21-41 I

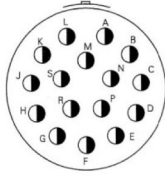

21-16 II

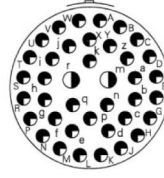

21-39 I

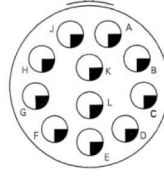

21-11 II

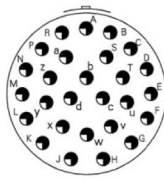

21-27 I

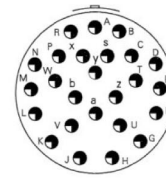

21-25 I

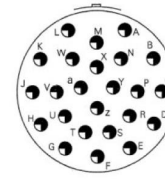

21-24 I

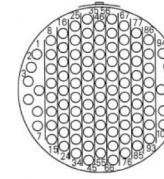

23-35 M

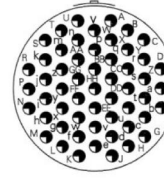

23-55 I

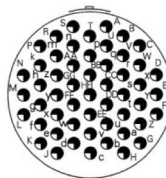

23-53 I

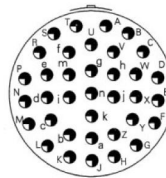

23-36 I

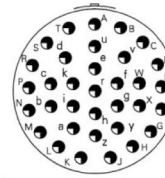

23-34 I

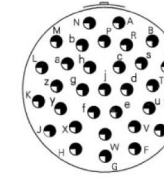

23-32 I

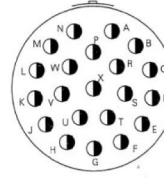

23-21 II

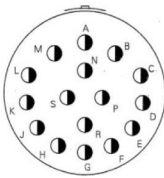

23-97 I

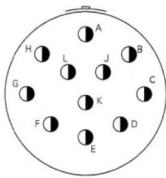

23-99 II

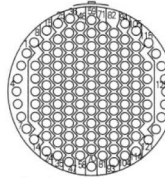

25-35 M

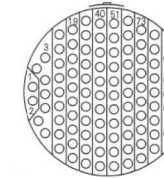

25-02 I

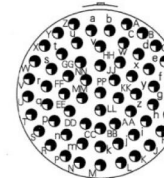

25-61 I

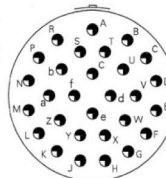

25-29 I

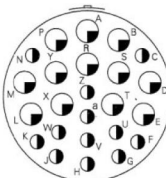

25-24 I

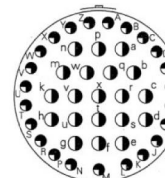

25-43 I

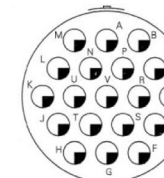

25-19 I

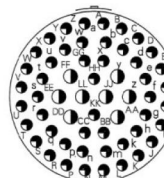

25-04 I

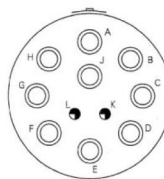

25-11

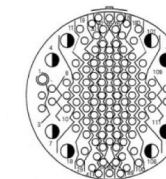

25-93 M



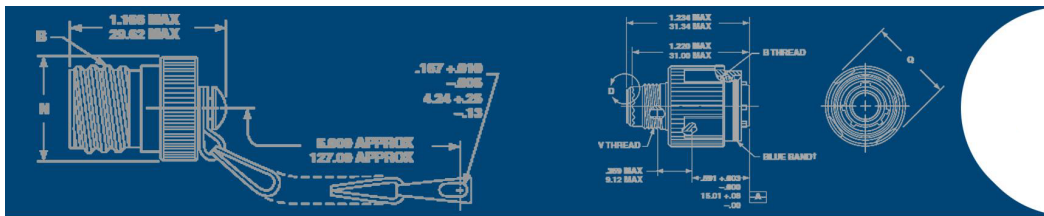

Key Orientation

Face View of Receptacle

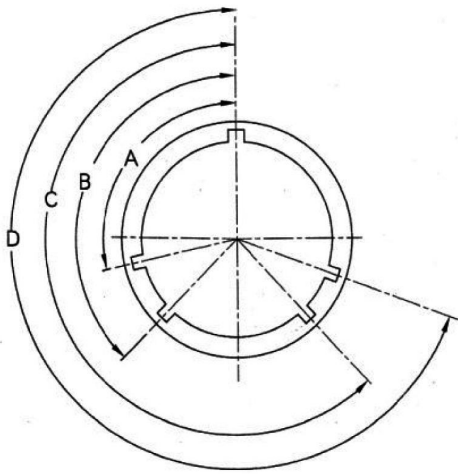

Face View of Plug

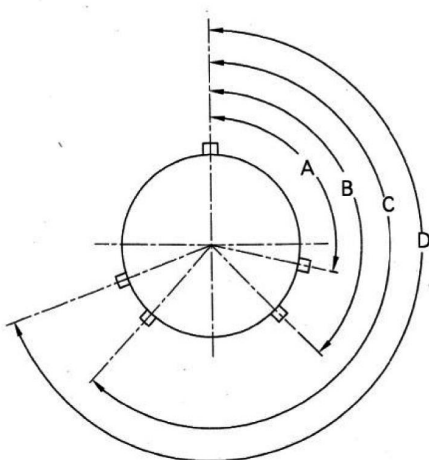

Shell Size	Orientation	N	A	B	C	D	E
9	A°	105	102	80	35	64	91
	B°	140	132	118	140	155	131
	C°	215	248	230	205	234	197
	D°	265	320	312	275	304	240
11	A°	95	113	90	53	119	51
	B°	141	156	145	156	146	141
	C°	208	182	195	220	176	184
	D°	236	292	252	255	298	242
13	A°	95	113	90	53	119	51
	B°	141	156	145	156	146	141
	C°	208	182	195	220	176	184
	D°	236	292	252	255	298	242
15	A°	95	113	90	53	119	79
	B°	141	156	145	156	146	153
	C°	208	182	195	220	176	197
	D°	236	292	252	255	298	272
17	A°	80	135	49	66	62	79
	B°	142	170	169	140	145	153
	C°	196	200	200	200	180	197
	D°	293	310	244	257	280	272
19	A°	80	135	49	66	62	79
	B°	142	170	169	140	145	153
	C°	196	200	200	200	180	197
	D°	293	310	244	257	280	272
21	A°	80	135	49	66	62	79
	B°	142	170	169	140	145	153
	C°	196	200	200	200	180	197
	D°	293	310	244	257	280	272
23	A°	80	135	49	66	62	79
	B°	142	170	169	140	145	153
	C°	196	200	200	200	180	197
	D°	293	310	244	257	280	272
25	A°	80	135	49	66	62	79
	B°	142	170	169	140	145	153
	C°	196	200	200	200	180	197

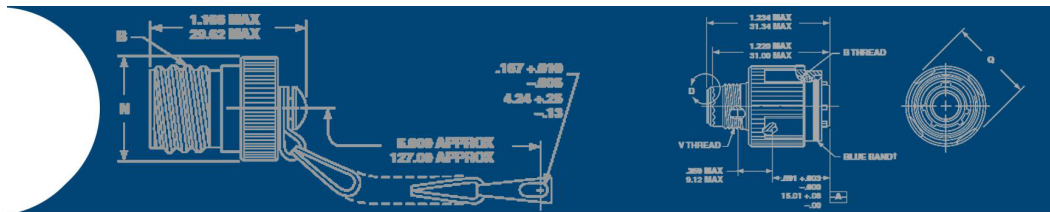

MIL-DTL-38999 series III, IV back shell

How to Order

	M85049/	38	-15	N	09	A
Basic series						
Type						
14 = Back nut						
16 = 90° elbow cable clamp						
18 = Straight cable clamp with shielding						
20 = Shielding back shell						
38 = Straight cable clamp						
39 = 90° elbow cable clamp with shielding						
69 = Heat shrinkable sleeve						
01 = Earthing and impaction						
06 = Spring thread-guard						
91 = Straight cable clamp (composite material)						
92 = 90° elbow cable clamp (composite material)						
Shell size						
09, 11, 13, 15, 17, 19, 21, 23, 25						
Finish						
W = Olive green cadmium plating						
N = Electroless nickel plating						
S = Stainless steel passivated						
A = Black anodized						
J = Olive green cadmium plating (composite material)						
M = Electroless nickel plating (composite material)						
Outlet diameter						
Omit = Standard size						
01 = 1.57 ~ 3.18 mm, 02 = 3.18 ~ 6.35 mm						
03 = 6.35 ~ 9.53 mm, 04 = 9.53 ~ 12.70 mm						
05 = 12.70 ~ 15.88 mm, 06 = 15.88 ~ 19.05 mm						
07 = 19.05 ~ 22.23 mm, 08 = 22.23 ~ 25.40 mm						
09 = 25.40 ~ 28.58 mm, 10 = 28.58 ~ 31.75 mm						
Length						
Omit = Standard length (64.4 mm)						
A = 89.8 mm						
B = 115.2 mm						
C = 140.6 mm						

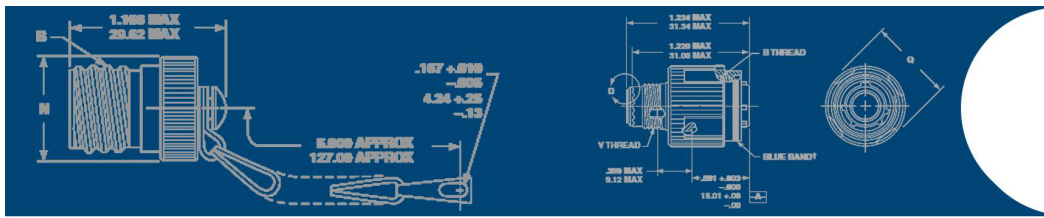

Size for Back Shell

Back nut (M85049/14)

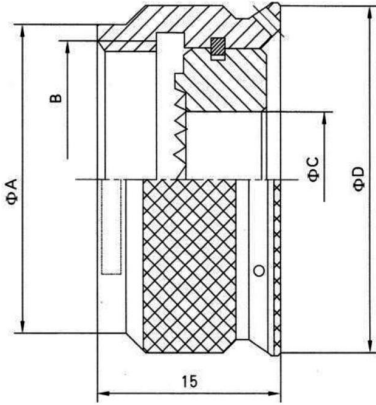

Shell No.	A	Thread B	C	D
09	15.2	M12*1	6.7	18.0
11	18.2	M15*1	9.9	21.0
13	21.2	M18*1	12.8	24.0
15	25.1	M22*1	16.0	28.0
17	28.1	M25*1	19.2	31.0
19	31.1	M28*1	21.4	34.0
21	34.0	M31*1	24.6	37.0
23	37.0	M34*1	27.7	40.0
25	40.0	M37*1	30.9	43.0

Shielding back shell (M85049/20)

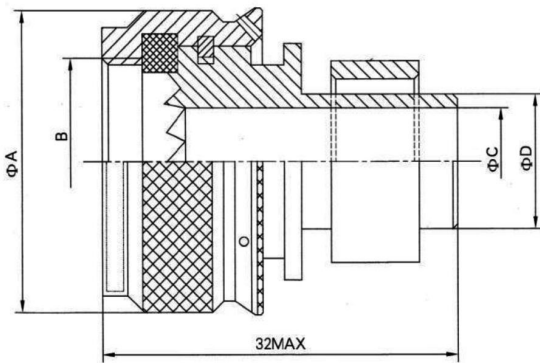

Shell	A	Thread B	C	D
0	18.	M12*1	6.5	8.8
1	21.	M15*1	8.6	12.65
1	24.	M18*1	10.90	12.95
1	28.	M22*1	14.10	16.00
1	31.	M25*1	17.25	19.30
1	34.	M28*1	20.40	22.61
2	37.	M31*1	23.60	25.65
2	40.	M34*1	26.40	28.70
2	43.	M37*1	28.40	30.53

Heat shrinkable sleeve (M85049/69)

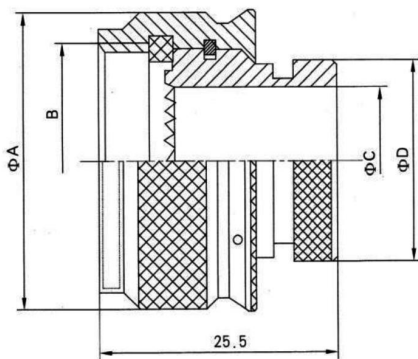

Shell No.	A	Thread B	C	D
09	18.0	M12*1	6.	13.5
11	21.0	M15*1	9.	15.3
13	24.0	M18*1	12.8	19.6
15	28.0	M22*1	16.0	21.2
17	31.0	M25*1	19.2	24.4
19	34.0	M28*1	21.4	26.4
21	37.0	M31*1	24.6	30.9
23	40.0	M34*1	27.7	34.4
25	43.0	M37*1	30.9	36.6

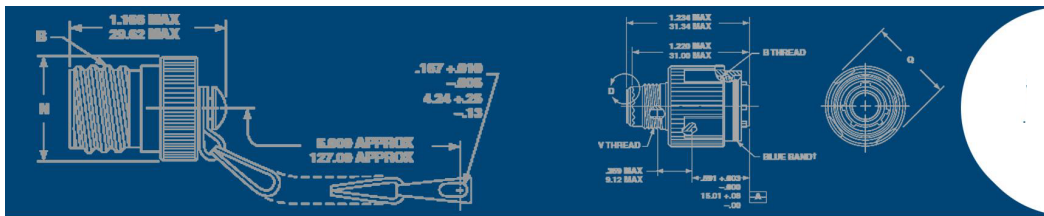

90° elbow cable clamp (M85049/16)

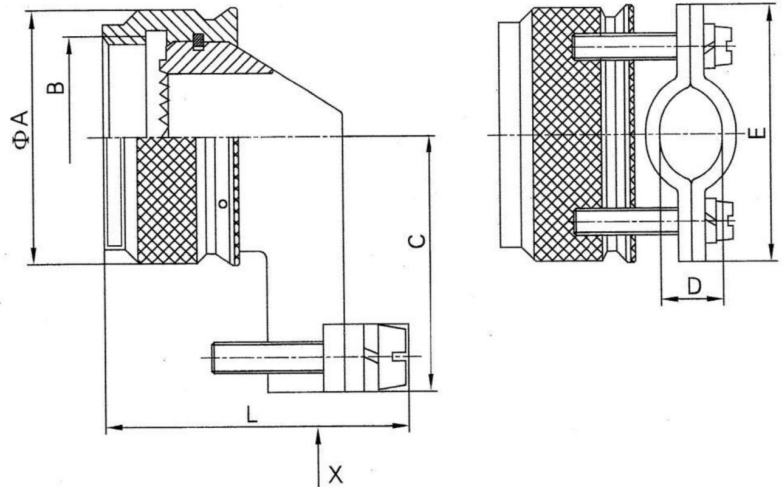

Shell	A	Thread B	C (max)	D (min)	D (max)	E (max)	L (max)
0	19.0	M12*1	20.0	2.85	6.71	21.0	25.9
1	22.0	M15*1	21.5	6.00	9.96	26.5	29.2
1	25.1	M18*1	23.0	8.45	12.85	31.5	32.0
1	29.0	M22*1	25.0	12.00	16.03	36.5	35.2
1	32.1	M25*1	27.0	11.10	19.20	31.0	36.4
1	35.1	M28*1	28.5	13.75	21.46	37.0	40.7
2	38.1	M31*1	29.5	19.30	24.64	35.0	43.8
2	41.1	M34*1	31.0	21.40	27.81	35.0	43.0
2	44.1	M37*1	33.0	23.50	30.99	37.0	44.2

Earthing and impaction (M85049/01)

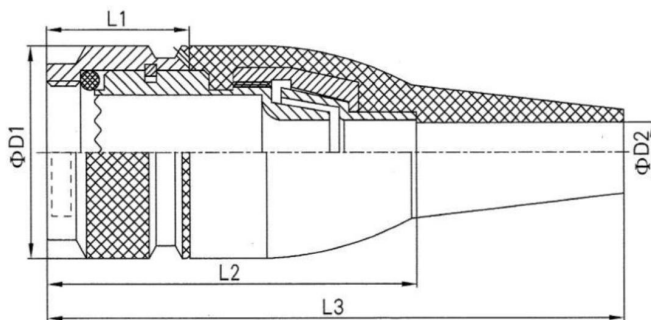

P/N	D1	D2	L1	L2	L3
M85049 01-08N	18.0	7.0	14.8	37.0	53.0
M85049 01-10N	21.0	10.0	14.8	37.0	53.0
M85049 01-12N	24.0	13.0	14.8	37.0	53.0
M85049 01-14N	28.0	15.0	14.8	40.0	73.0
M85049 01-16N	31.0	18.0	14.8	40.0	73.0
M85049 01-18N	34.0	20.0	14.8	40.0	73.0
M85049 01-20N	37.0	23.5	14.8	45.0	73.0
M85049 01-22N	40.0	26.5	14.8	45.0	73.0
M85049 01-24N	43.0	29.0	14.8	45.0	73.0

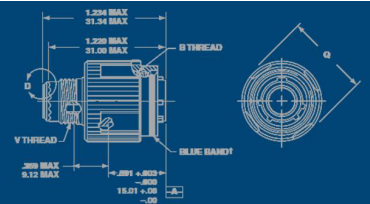
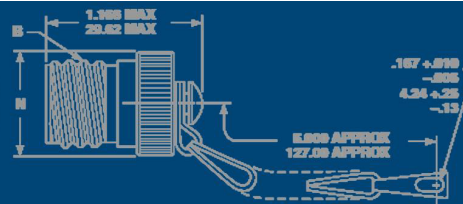

Protecting cable by spring (M85049/06)

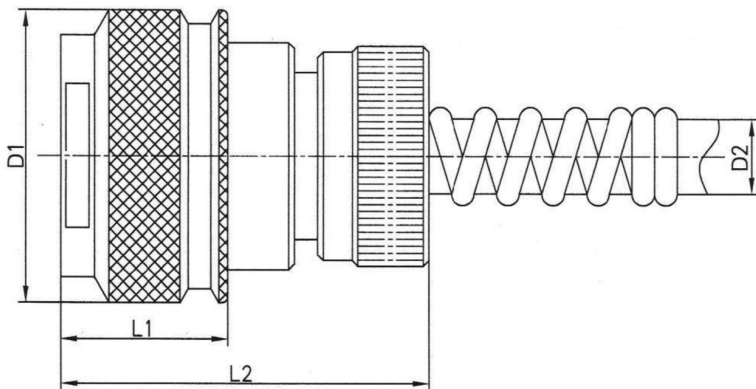

P/	D1	D2	L1	L2
M85049 01-09N	18.0	7.0	14.8	37.0
M85049 01-11N	21.0	10.0	14.8	37.0
M85049 01-13N	24.0	13.0	14.8	37.0
M85049 01-15N	28.0	15.0	14.8	40.0
M85049 01-17N	31.0	18.0	14.8	40.0
M85049 01-19N	34.0	20.0	14.8	40.0
M85049 01-21N	37.0	23.5	14.8	45.0
M85049 01-23N	40.0	26.5	14.8	45.0
M85049 01-25N	43.0	29.0	14.8	45.0

Straight cable clamp (M85049/38-NB)

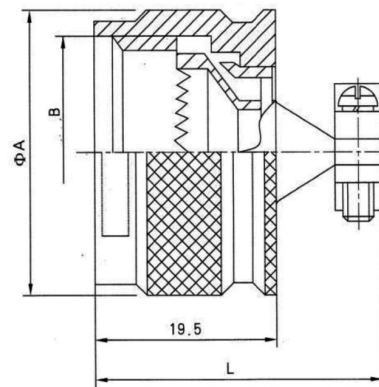
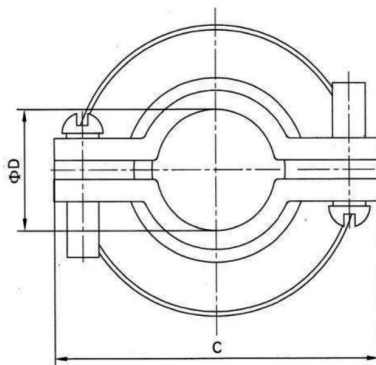

P/	A	Thread	C	D (min)	D (max)	L
M85049 38-09N	16.4	M12*1	18.6	3.	5.	29.2
M85049 38-11N	19.2	M15*1	20.6	5.	7.	29.2
M85049 38-13N	23.0	M18*1	24.5	7.	11.	29.2
M85049 38-15N	25.7	M22*1	26.0	9.	12.9	29.8
M85049 38-17N	29.0	M25*1	33.0	12.8	17.0	31.0
M85049 38-19N	31.5	M28*1	36.3	13.2	17.9	32.0
M85049 38-21N	34.7	M31*1	39.0	14.8	21.1	32.0
M85049 38-23N	37.5	M34*1	41.4	16.4	24.3	32.0
M85049 38-25N	41.0	M37*1	44.5	18.0	27.5	32.0

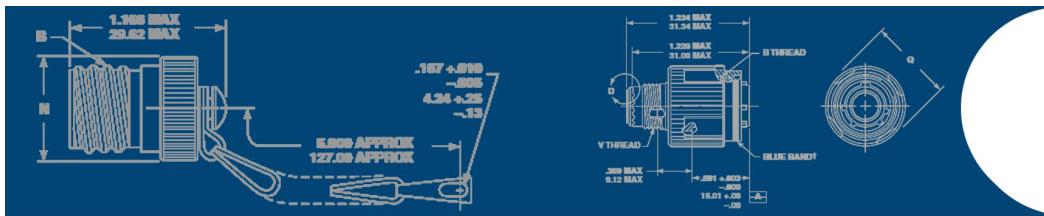

Straight cable clamp with shielding (M85049/18)

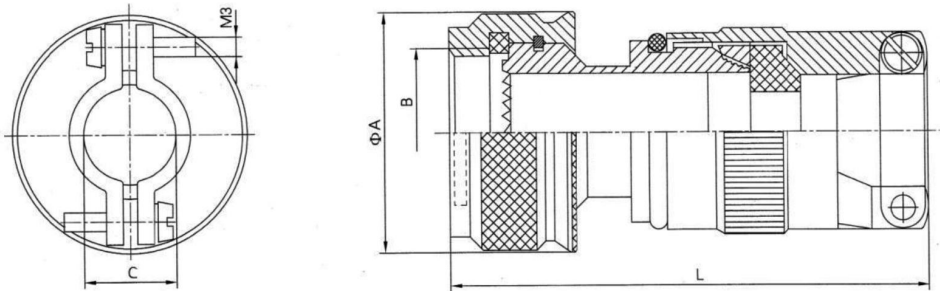

Shell No.	Number for hole of cable	A	Thread B
09	01 ~ 02	19	M12*1
11	01 ~ 03	22	M15*1
13	02 ~ 04	25.1	M18*1
15	02 ~ 05	29	M22*1
17	02 ~ 06	32	M25*1
19	03 ~ 07	35	M28*1
21	03 ~ 08	38	M31*1
23	03 ~ 09	41.1	M34*1
25	04 ~ 10	41.1	M37*1

Number for hole of cable	Diameter for
01	1.57 ~ 3.18
02	3.18 ~ 6.35
03	6.35 ~ 9.53
04	9.53 ~ 12.7
05	12.7 ~ 15.88
06	15.88 ~ 19.05
	19.05 ~ 22.23
08	22.23 ~ 25.40
09	25.40 ~ 28.58
10	28.58 ~ 31.75

Shell No.	Number for length	L
09 ~ 25	Standard (may omit)	64.4
09 ~ 25	A	89.8
15 ~ 25	B	115.2
21 ~ 25	C	140.

Shielding back shell (M85049/20-J)

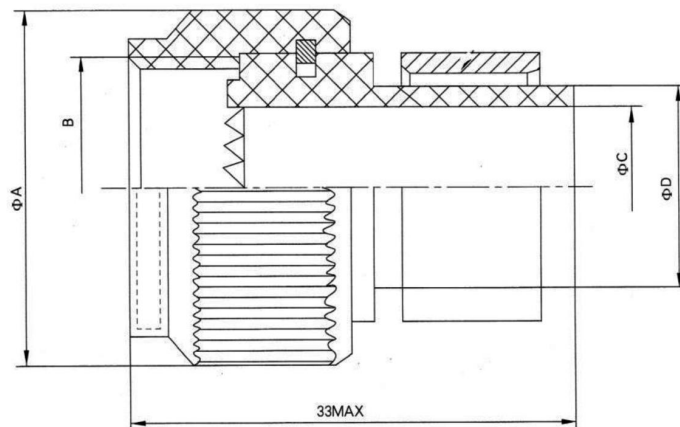

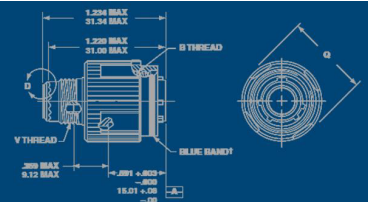
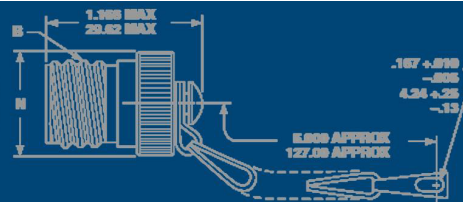

P/	A	Thread B	C	D
M85049 20-09J	21.8	M12*1	6.73	12.65
M85049 20-11J	25.0	M15*1	8.71	12.95
M85049 20-13J	29.5	M18*1	11.10	16.00
M85049 20-15J	32.5	M22*1	14.27	19.30
M85049 20-17J	35.5	M25*1	17.45	22.61
M85049 20-19J	38.5	M28*1	20.62	25.65
M85049 20-21J	41.5	M31*1	23.80	28.70
M85049 20-23J	45.0	M34*1	26.57	30.53
M85049 20-25J	48.0	M37*1	28.58	34.52

Straight cable clamp (M85049/91-J)

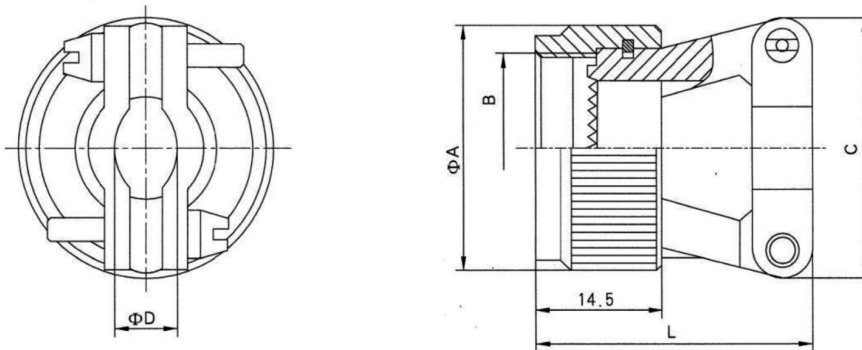

Shell No.	A (max)	Thread B	C (max)	D (min)	D (max)	L (max)
0	21.8	M12*1	20.0	4.00	5.94	27.0
1	25.0	M15*1	20.0	4.00	5.94	28.5
1	29.5	M18*1	23.4	4.83	8.33	30.0
1	32.5	M22*1	26.6	6.60	11.61	31.5
1	35.5	M25*1	30.6	7.19	15.60	33.5
1	38.5	M28*1	34.0	8.26	16.10	36.6
2	41.5	M31*1	35.8	8.71	17.73	39.8
2	45.0	M34*1	39.0	9.68	20.90	42.9
2	48.0	M37*1	40.6	10.62	21.66	45.0

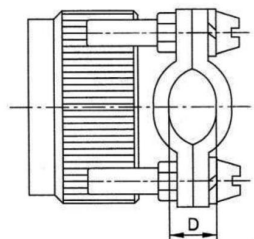
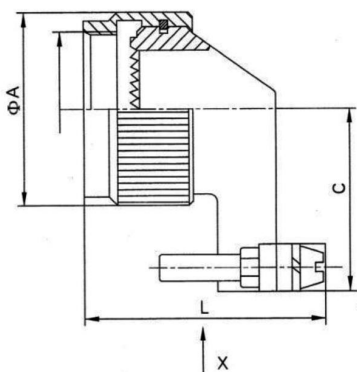

90° elbow cable clamp (M85049/92-J)

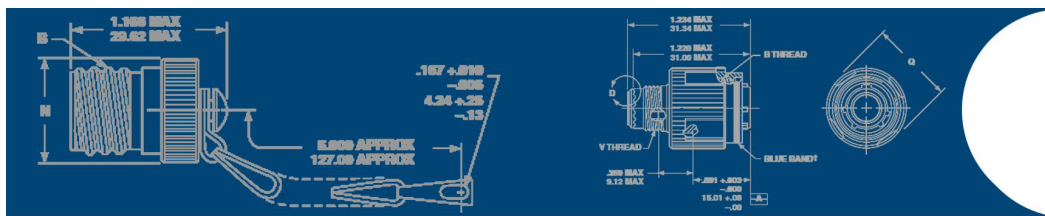

Shell No.	A (max)	Thread B	C (max)	D (min)	D (max)	L (max)
09	21.8	M12*1	20.6	2.49	5.94	29.5
11	25.0	M15*1	22.0	3.87	5.94	29.5
13	29.5	M18*1	23.6	4.83	8.33	31.9
15	32.5	M22*1	25.2	6.60	11.61	35.1
17	35.5	M25*1	26.8	7.19	15.60	39.1
19	38.5	M28*1	31.3	8.26	16.10	41.5
21	41.5	M31*1	32.9	8.71	17.73	43.3
23	45.0	M34*1	34.5	9.68	20.90	46.5
25	48.0	M37*1	36.1	10.62	21.66	47.1

